

2 YEAR
WARRANTY

MADE IN
USA

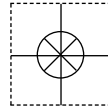

User's Guide

Shop online at

omega.com[®]

Ω OMEGA[®]

www.omega.com

e-mail: info@omega.com

ISO 9001
CERTIFIED
CORPORATE QUALITY

STAMFORD, CT

ISO 9002
CERTIFIED
CORPORATE QUALITY

MANCHESTER, UK



FPU5-MT-110, FPU5-MT-220
OMEGAFLEX[®]
Peristaltic Pump Motor



OMEGAnet® Online Service
www.omega.com

Internet e-mail
info@omega.com

Servicing North America:

USA:
ISO 9001 Certified

One Omega Drive, P.O. Box 4047
Stamford CT 06907-0047
TEL: (203) 359-1660 FAX: (203) 359-7700
e-mail: info@omega.com

Canada:

976 Bergar
Laval (Quebec) H7L 5A1
TEL: (514) 856-6928 FAX: (514) 856-6886
e-mail: info@omega.ca

For immediate technical or application assistance:

USA and Canada: Sales Service: 1-800-826-6342 / 1-800-TC-OMEGA®
Customer Service: 1-800-622-2378 / 1-800-622-BEST®
Engineering Service: 1-800-872-9436 / 1-800-USA-WHEN®
TELEX: 996404 EASYLINK: 62968934 CABLE: OMEGA

Mexico:

En Español: (001) 203-359-7803 e-mail: espanol@omega.com
FAX: (001) 203-359-7807 info@omega.com.mx

Servicing Europe:

Benelux:

Postbus 8034, 1180 LA Amstelveen, The Netherlands
TEL: +31 (0)20 3472121 FAX: +31 (0)20 6434643
Toll Free in Benelux: 0800 0993344
e-mail: sales@omegaeng.nl

Czech Republic:

Rudé armády 1868, 733 01 Karviná 8
TEL: +420 (0)59 6311899 FAX: +420 (0)59 6311114
Toll Free: 0800-1-66342 e-mail: info@omegashop.cz

France:

11, rue Jacques Cartier, 78280 Guyancourt, France
TEL: +33 (0)1 61 37 29 00 FAX: +33 (0)1 30 57 54 27
Toll Free in France: 0800 466 342
e-mail: sales@omega.fr

Germany/Austria:

Daimlerstrasse 26, D-75392 Deckenpfronn, Germany
TEL: +49 (0)7056 9398-0 FAX: +49 (0)7056 9398-29
Toll Free in Germany: 0800 639 7678
e-mail: info@omega.de

United Kingdom:

ISO 9002 Certified

One Omega Drive, River Bend Technology Centre
Northbank, Irlam, Manchester
M44 5BD United Kingdom
TEL: +44 (0)161 777 6611 FAX: +44 (0)161 777 6622
Toll Free in United Kingdom: 0800-488-488
e-mail: sales@omega.co.uk

It is the policy of OMEGA to comply with all worldwide safety and EMC/EMI regulations that apply. OMEGA is constantly pursuing certification of its products to the European New Approach Directives. OMEGA will add the CE mark to every appropriate device upon certification.

The information contained in this document is believed to be correct, but OMEGA Engineering, Inc. accepts no liability for any errors it contains, and reserves the right to alter specifications without notice.

WARNING: These products are not designed for use in, and should not be used for, patient-connected applications.

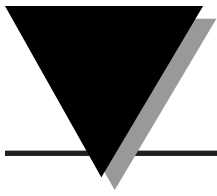

Unpacking Instructions

Remove the Packing List and verify that you have received all equipment, including the following (quantities in parentheses):

FPU5-MT-110 or FPU5-MT-220 Peristaltic Pump Motor (1)

Power Cord (1)

Spare Fuse (1)

Peristaltic Pump Quick Start Manual (Manual Number MQS2219) (1)

Peristaltic Pump Motor Quick Start Manual (Manual Number MQS2299) (1)

Operator's Manual (1)

If you have any questions about the shipment, please call the Customer Service Department. When you receive the shipment, inspect the container and equipment for signs of damage. Note any evidence of rough handling in transit. Immediately report any damage to the shipping agent.

NOTE

The carrier will not honor damage claims unless all shipping material is saved for inspection. After examining and removing contents, save packing material and carton in the event reshipment is necessary.

From the Technical Library of _____

	Page
Unpacking Instructions	i
Chapter 1 Introduction	1-1
1.1 Description	1-1
1.2 Features	1-1
Chapter 2 Parts of the Pump Motor	2-1
2.1 Front View	2-1
2.2 Left Side View	2-2
2.3 Right Side View	2-3
2.4 Membrane Keypad and Display	2-4
2.5 Rear View	2-6
Chapter 3 Getting Started	3-1
3.1 Attaching the Pump	3-1
3.1.1 Introduction	3-1
3.1.2 Attaching a Single Pump Directly to the Motor	3-2
3.1.3 Stacking Two Pumps on One Side of the Motor	3-3
3.2 Selecting Tubing	3-4
3.3 Tubing Life	3-4
3.4 Loading the Tubing	3-4
Chapter 4 Turning on the Power	4-1
4.1 Introduction to the Two Display Modes	4-1
4.2 Using the ON/OFF Switch	4-1
4.3 The STOPPED Display Mode	4-1
4.4 The RUNNING Display Mode	4-2
Chapter 5 Operating the Pump Motor in the STOPPED Display Mode ..	5-1
5.1 Displaying Pump Messages in Five Different Languages	5-1
5.2 Defining the Direction of Pumping	5-3
5.3 Selecting the Tubing Inner Diameter	5-4
5.4 Priming the Tubing	5-6
5.5 Calibrating the Tubing	5-6
5.6 Measuring the Temperature of a Fluid	5-9
5.7 Preparing for Pumping in a Specific Mode	5-9
Chapter 6 Operating the Pump Motor in the RUNNING Display Mode .	6-1
6.1 The RPM Mode	6-1
6.1.1 Pumping in the RPM Mode	6-1
6.2 The FLOW RATE Mode	6-5
6.2.1 Pumping in the FLOW RATE Mode	6-5
6.3 The TIME Mode	6-11
6.3.1 Pumping in the TIME Mode	6-11
6.4 The TOTAL VOLUME Mode	6-16
6.4.1 Pumping in the Total Volume Mode	6-17
6.5 Preventing Tubing from Moving During Pump Operation .	6-21

	Page
6.6 Other Pumping Options	6-21
6.6.1 Auxiliary Out (Remote Monitor)	6-21
6.6.2 Auxiliary In (Remote Start/Stop)	6-22
Chapter 7 Troubleshooting Guide	7-1
7.1 Display Error Messages	7-1
7.2 Other Pumping Problems	7-8
Chapter 8 Technical Details	8-1
8.1 Theory of Operation	8-1
8.2 Design Considerations	8-1
8.3 Design Solution	8-1
8.4 Maintenance	8-1
Chapter 9 Specifications	9-1
Chapter 10 Spare Parts and Accessories	10-1

NOTE

This equipment has been tested and found to comply with the limits for a Class A digital device, pursuant to part 15 of the FCC Rules. These limits are designed to provide reasonable protection against harmful interference when the equipment is operated in a commercial environment. This equipment generates, uses, and can radiate radio frequency energy and, if not installed and used in accordance with the Operator’s Manual, may cause harmful interference to radio communications. Operation of this equipment in a residential area is likely to cause harmful interference in which case the user will be required to correct the interference at his own expense.

Notes

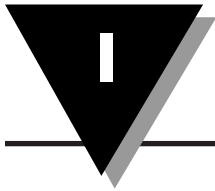

Index

A	
Accessories	10-1
Auxiliary In	6-22
Auxiliary Out	6-21
C	
Calibrating the Tubing	5-6
Calibration Accuracy	9-1
Creeping, Preventing	6-21
D	
Dual Pump Mounting	3-3
E	
Error Messages	7-1
F	
Flow Rate Mode	1-1, 6-5
Fluid Temperature, Measuring	5-9
I	
Inner Tubing Diameters	5-5
K	
Keypad, Parts of	2-4
L	
Language Button	2-7
Languages	5-1
Line Filter	4-1
Loading Tubing.....	3-4
M	
Modes	
Flow Rate	1-1, 6-5
RPM	1-1, 6-1
Time	1-1, 6-11
Total Volume	1-1, 6-17
Motor Turning	
Clockwise	5-4
Counter-clockwise	5-4
Mounting Configurations	3-1
P	
Parts of the Pump Motor	
Bottom Alignment Pin	2-2
Display	2-1
Face of Motor	2-2
Fuse	2-2, 2-6
Groove of Motor Shaft	2-2
Membrane Keypad	2-1, 2-4
Motor Shaft	2-2
Mounting Holes	2-2
ON/OFF Switch	2-1
Rubber Feet	2-1
Safety Cover	2-3
Top Alignment Pin	2-2
Power Requirement	4-1
Priming the Tubing	5-6
Pump Direction, Changing	5-3
Pump Messages in	
English	5-2
French	5-2
German	5-2
Italian	5-2
Spanish	5-2
R	
Ranges	
Flow Rate	6-6
RPM	6-2
Time	6-12
Total Volume	6-17
RPM Mode	1-1, 6-1
Running Display Mode	4-2
S	
Safety Cover	2-3
Single Pump Mounting	3-2
Spare Parts	10-1
Specifications	9-1
Stopped Display Mode	4-1
T	
Thermocouple Probe (Type K) ...	1-1, 10-1
Time Mode	1-1, 6-11
Total Volume Mode	1-1, 6-16
Tubing	
Durometer	9-2
Inlet	5-4
Life	3-4
Loading	3-4
Materials	3-4
Outlet	5-4
Sizes	3-4
Troubleshooting Guide	7-1



Notes



1.1 Description

The peristaltic pump motor offers microprocessor control and a digital display, and is designed to be fully compatible with our peristaltic pump. No mounting plate is needed, just two mounting screws. A 1/10 HP (75W) motor provides flow rates of up to 2280 mL/minute. A convenient membrane keypad lets you enter values and control all pump operations. A dot matrix LCD provides for easy view. Calibrating the unit is easy with the user-friendly control software. Simply select a tubing size and the desired flow rate, and the pump motor locks in the required RPM. Select nominal calibration values stored in ROM (read only memory) or calibrate via gravimetric measurements. Fluid temperature may be displayed (using an optional Type K thermocouple probe). The last motor settings are stored in memory when the drives are shut off.

The peristaltic pump motor provides you with four different modes of pumping:

- The RPM Mode for pumping at a certain RPM setting for an unlimited period of time
- The FLOW RATE Mode for pumping at a certain FLOW RATE setting for an unlimited period of time
- The TIME Mode for pumping at a certain RPM or FLOW RATE setting for a specific period of time
- The TOTAL VOLUME Mode for pumping at a certain RPM or FLOW RATE setting to dispense a specific amount of fluid

The pump is available in two versions: 110Vac and 220Vac.

1.2 Features

- Digital Display of Flow Rate, RPM, Total Volume, Fluid Temperature (°C or °F), Flow Duration, or Tube ID
- Ability to Calibrate Precise Flow Rates
- Flow Rates of 1 to 2280 mL/minute
- Reversible Motor for Pumping in Both Directions at Speeds of 10 to 600 RPM
- Easy-to-Read LCD Display
- Type K SMP Female Thermocouple Input
- Tachometer Feedback, ±0.5% Speed Control
- Accepts Two Pumps, One on Each Side or Two Stacked Together
- Membrane Keypad for Easy Operation and Calibration
- Remote Control Options - Aux In: Remote Start/Stop, TTL/CMOS
Aux Out: Open Collector
- Built-in Electronic Braking and Reversing for Fast Stops and Directional Changes
- Accepts Metric or English Tube Sizes
- Displays Information in English, French, Spanish, German, or Italian

<h2>Notes</h2>

2

Parts of the Pump Motor

2.1 Front View

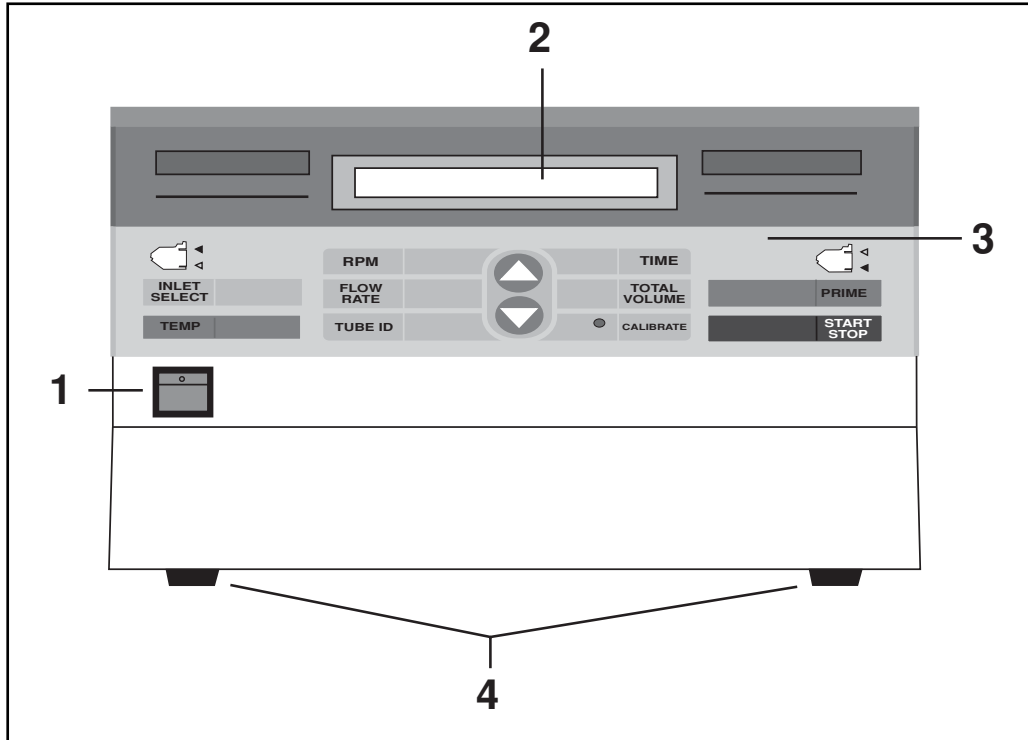

Figure 2-1. Front View of the Pump Motor

Table 2-1. Front View		
Item	Description	Function
1	ON/OFF Switch	Toggles the unit's power on and off
2	Display	Displays the pump messages; provides information while the pump is running
3	Membrane Keypad	Allows you to select pump functions
4	Rubber Feet	Support the pump motor on a table surface

2.2 Left Side View

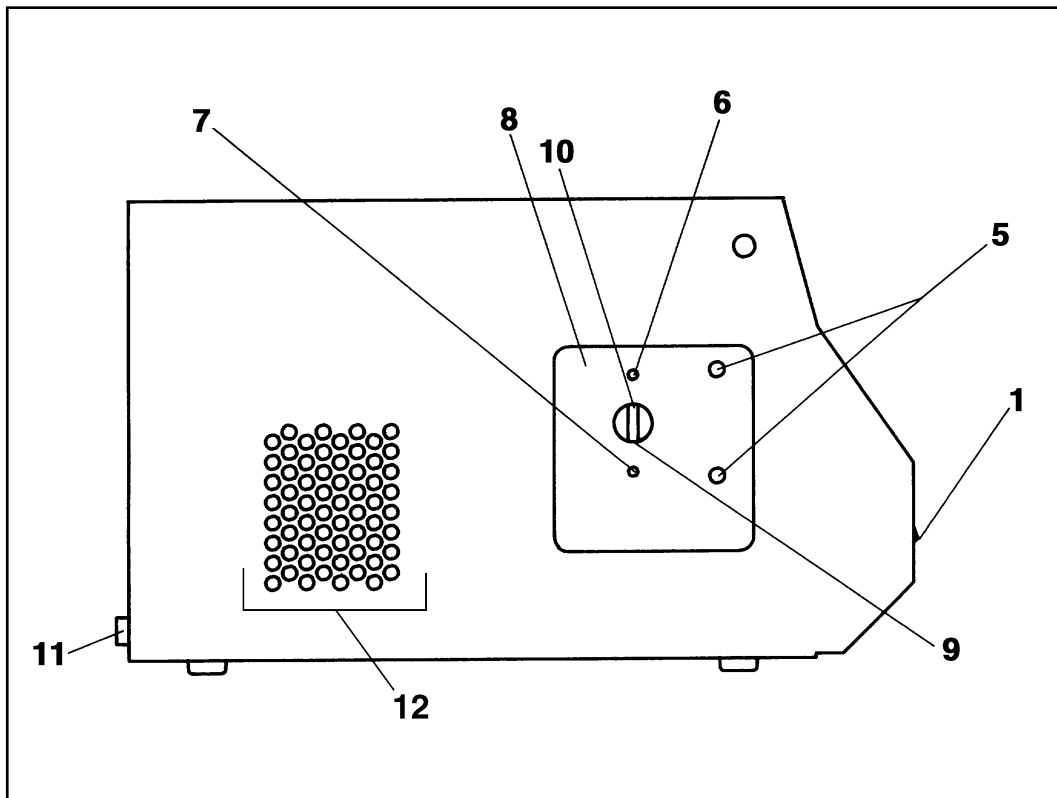

Figure 2-2. Left Side View of the Pump Motor

Table 2-2. Left Side View

Item	Description	Function
1	ON/OFF Switch	Toggles the pump motor's power on and off
5	Mounting Holes	Provides attachment sites for pump(s)
6	Top Alignment Pin	Aligns the pump head during installation
7	Bottom Alignment Pin	Aligns the pump head during installation
8	Face of Motor	Provides a surface for attaching pump(s)
9	Motor Shaft	Turns the rotor assembly of pump(s) during pumping
10	Groove of Motor Shaft	Holds the back tab of pump(s) rotor shaft
11	Fuse	Protects the unit from an overcurrent
12	Vent Holes	Allow for cooling of pump motor

2.3 Right Side View

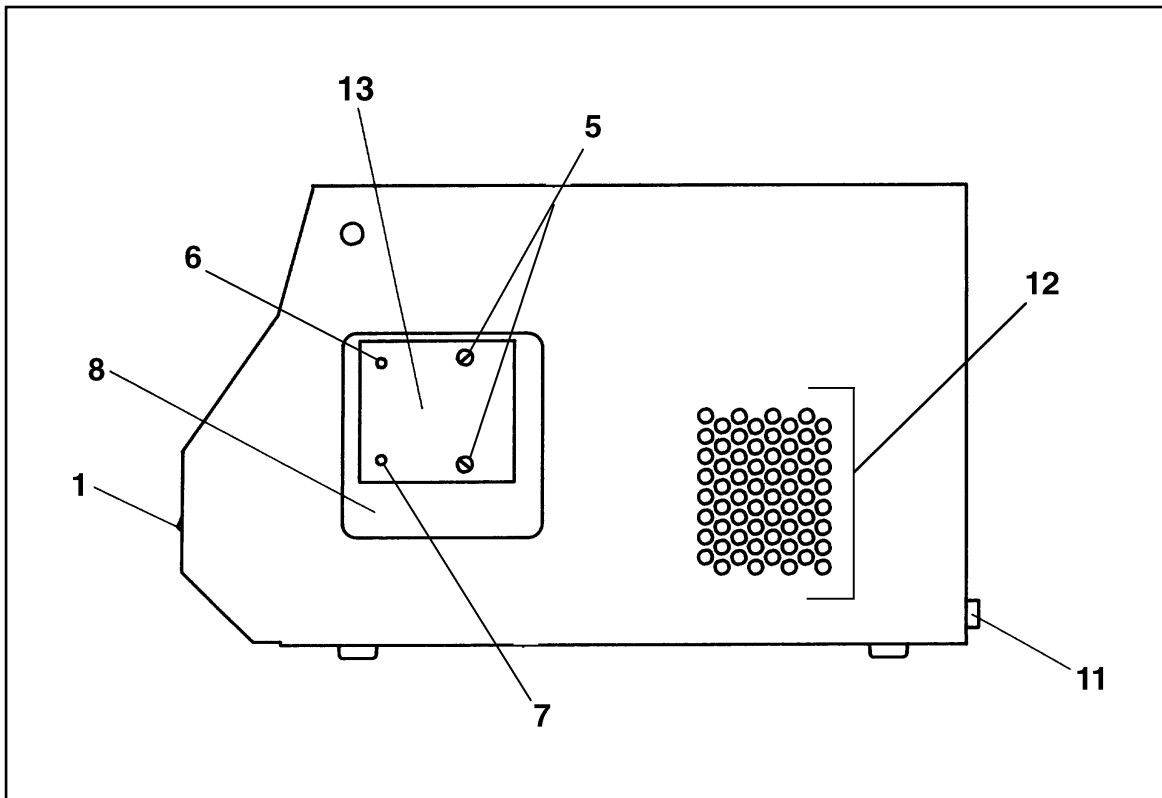

Figure 2-3. Right Side View of the Pump Motor

Table 2-3. Right Side View

Item	Description	Function
1	ON/OFF Switch	Toggles the pump motor's power on and off
5	Safety Cover Screws	Secure safety cover to the motor - if safety cover is not in place, the exposed holes are the Mounting Holes
6	Top Alignment Pin	Aligns the pump head during installation
7	Bottom Alignment Pin	Aligns the pump head during installation
8	Face of Motor	Provides a surface for attaching pump(s)
11	Fuse	Protects the unit from an overcurrent
12	Vent Holes	Allow for cooling of pump motor
13	Safety Cover (default side for shipping)	Prevents fingers and clothing from getting caught in the motor shaft during pump operation

2.4 Membrane Keypad and Display

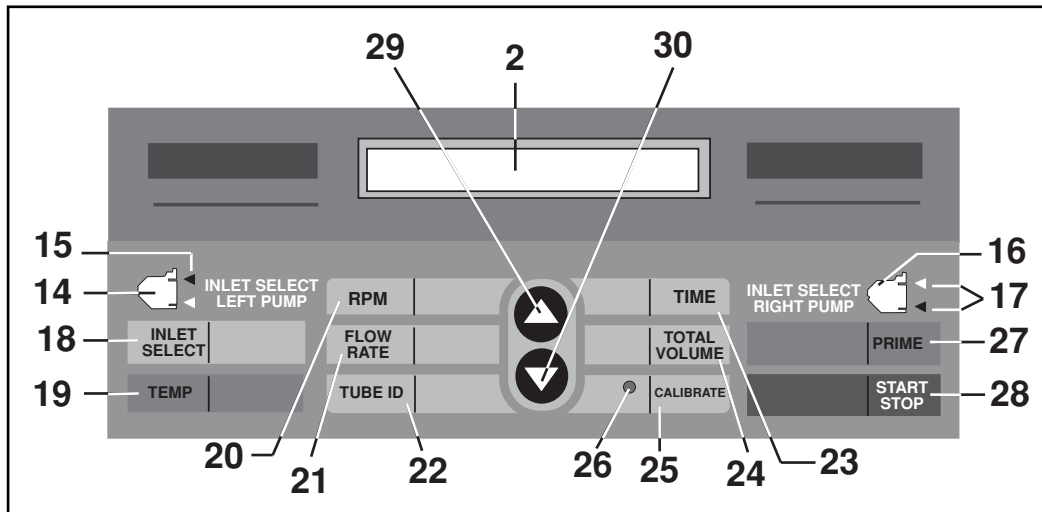

Figure 2-4. Membrane Keypad and Display

Table 2-4. Membrane Keypad Detail

Item	Description	Function
2	Display	Shows pump messages; provides quantitative information while the pump is running
14	Left Pump Icon	Side view of a pump(s); associated with two green LEDs
15	Green LEDs for left pump	Indicate left-mounted pump's inlet and outlet
16	Right Pump Icon	Side view of a pump(s); associated with two green LEDs
17	Green LEDs for right pump	Indicate right-mounted pump's inlet and outlet
18	<i>INLET SELECT</i> key	Selects tubing inlet for pump(s) mounted on either side of the motor
19	<i>TEMP</i> key	Displays the fluid's temperature as measured via an optional Type K thermocouple probe
20	<i>RPM</i> key	Initiates the RPM Mode of pumping and displays the RPM setting of the pump motor; displays the actual pump motor speed, as it occurs in time

Table 2-4. Membrane Keypad Details (cont'd)

Item	Description	Function
21	<i>FLOW RATE</i> key	Initiates the FLOW RATE Mode of pumping and displays the FLOW RATE setting of the pump motor; displays the actual fluid flow rate, as it occurs in time
22	<i>TUBE ID</i> key	Selects the inner diameter of a tube
23	<i>TIME</i> key	Initiates the TIME Mode of pumping and displays the TIME setting of the pump motor; displays of the actual time for which the pump has been running
24	<i>TOTAL VOLUME</i> key	Initiates the TOTAL VOLUME Mode of pumping and displays of the TOTAL VOLUME setting of the pump motor; displays the actual volume of fluid dispensed, as it occurs in time
25	<i>CALIBRATE</i> key	Starts and completes calibration of a tube
26	Red LED for the <i>CALIBRATE</i> key	Lights after calibration is complete, indicating that the motor is pumping according to that calibration
27	<i>PRIME</i> key	Allows for momentary running of the motor; useful for filling a tube with fluid before calibrating
28	<i>START/STOP</i> key	Alternately starts and stops the pump
29	▲ (<i>UP ARROW</i> key)	Increases values of a setting after you have pressed a key choosing that setting (refer to Table 2-5)
30	▼ (<i>DOWN ARROW</i> key)	Decreases values of a setting after you have pressed a key choosing that setting (refer to Table 2-5)

Table 2-5. UP and DOWN ARROW Keys Scrolling Limits

If you last pressed the:	The ARROW Keys Will Scroll Through:
RPM key	RPM settings from 10 RPM to 600 RPM
TIME key	SECONDS (from 0 to 59), MINUTES (from 0 to 59), and HOURS (from 0 to 12); for overall TIME settings from 00:00:00 to 12:59:59
FLOW RATE key	FLOW RATE settings that depend on the tube size chosen
TOTAL VOLUME key	TOTAL VOLUME values from 1 mL to 10,000 liters
TUBE ID key	Pre-programmed tube inner diameters in inches or millimeters or the message "CALIBRATED TUBE!" (refer to Table 5-2)

2.5 Rear View

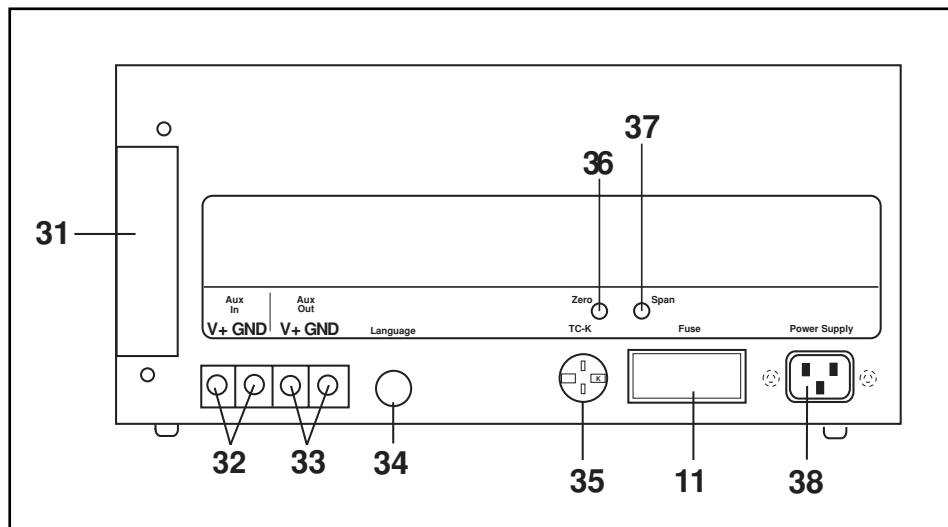

Figure 2-5. Rear View of the Pump Motor

Table 2-6. Rear View

Item	Description	Function
11	Fuse	Protects the unit from overcurrent
31	Removable Panel and Mounting Screws	Allows access to the circuit board for future upgrades
32	Auxiliary IN Terminals	Allow remote starting and stopping of the motor

Table 2-6. Rear View (cont'd)

Item	Description	Function
33	Auxiliary OUT Terminals	Allow remote monitoring of the motor's start or stop status
34	<i>LANGUAGE Button</i>	Changes the language of the pump messages in the display window
35	SMP Type K Thermocouple Connector	Allows the user to connect a Type K thermocouple probe and measure a fluid's temperature
36	Zero Potentiometer	Used for motor unit temperature calibration
37	Span Potentiometer	Used for motor unit temperature calibration
38	Power Supply	Connects to line cord and line voltage

3.1 Attaching the Pump

3.1.1 Introduction

There are five possible mounting configurations for using the peristaltic pump motor. Table 3-1 describes these mounting configurations.

Number of Pumps on Left Side	Number of Pumps on Right Side	Reference Section
1	0	3.1.2
0	1	3.1.2
2	0	3.1.3
0	2	3.1.3
1	1	3.1.2

NOTE

Your pump motor is equipped with a safety cover for whichever side of the motor is not being used.

You must remove the safety cover before attempting to attach pump(s) to the side.

3.1.2 Attaching a Single Pump Directly to the Motor

CAUTION

Perform ALL of the steps in Chapter 3 before turning the motor on.

Refer to Figures 3-1 through 3-4.

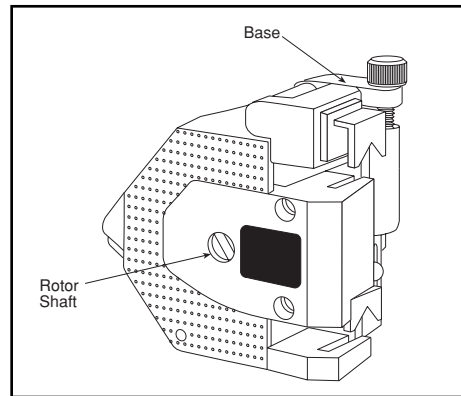

Figure 3-1. Pump in Closed Position

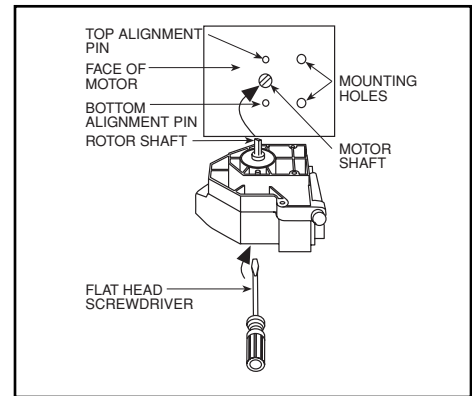

Figure 3-2. Aligning the Rotor Shaft

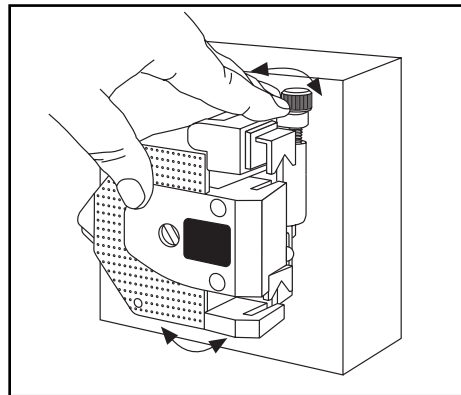

Figure 3-3. Pump in Closed Position

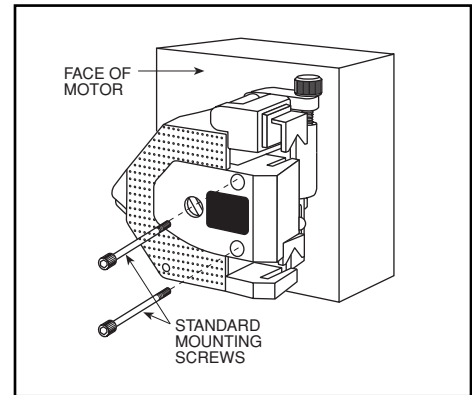

Figure 3-4. Aligning the Rotor Shaft

1. Remove the safety cover if it is on the side of the motor you wish to use. If you are using one side of the motor only, attach the safety cover to the other side.
2. Refer to Figure 3-1. Make sure the pump is in the closed position.
3. Refer to Figure 3-2. Place the blade of a flathead screwdriver in the groove of the Rotor Shaft. Rotate the Rotor Shaft until its back tab slips into the groove of the motor shaft. Do not try to force the pump onto the motor until you perform Step #4.
4. Refer to Figure 3-3. Swivel the pump back and forth slightly to align the holes on the back of the Base with the alignment pins on the face of the motor. Press the pump base up against the face of the motor.

5. Refer to Figure 3-4. With the pump and motor aligned, insert the mounting screws through the mounting holes in the pump, until they make contact with the threaded mounting holes in the face of the motor.
6. Tighten the screws fully with a 9/64 (M3.5) allen wrench.

3.1.3 Stacking Two Pumps on One Side of the Motor

CAUTION

Perform ALL of the steps in Chapter 3 before turning the motor on.

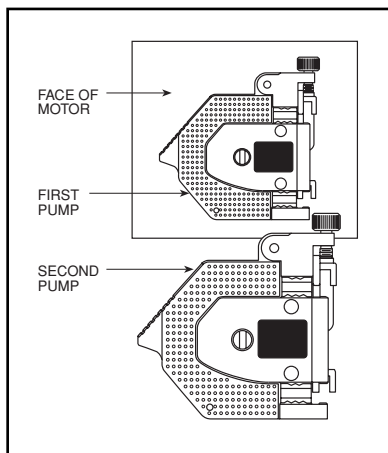

Figure 3-5. Placing the Second Pump on Top of the First Pump

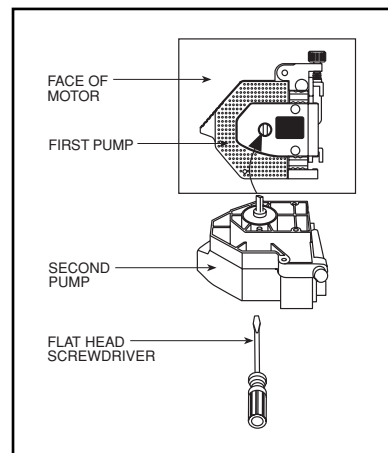

Figure 3-6. Aligning the Rotor Shaft of the Second Pump

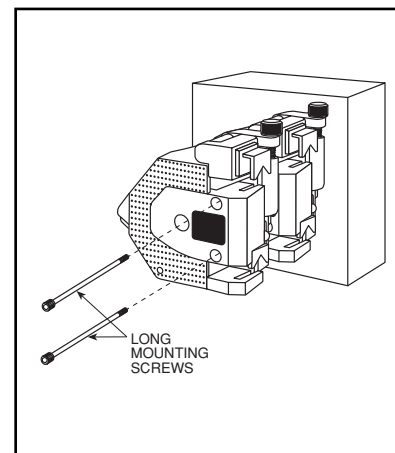

Figure 3-7. Securing Both Pumps to the Motor

1. Remove the safety cover if it is on the side of the motor you wish to use. Attach it to the other side.
2. Refer to Figure 3-1 through Figure 3-3. Perform Steps 1, 2 and 3 in Section 3.1.2 to put the first pump on the face of the motor.
3. Refer to Figure 3-1. Make sure the second pump is in the closed position.
4. Refer to Figure 3-5 and Figure 3-6. Place the blade of the flathead screwdriver in the groove of the Rotor Shaft of the second pump. Rotate the Rotor Shaft of the second pump until its back tab slips into the groove of the Rotor Shaft of the first pump.
5. Refer to Figure 3-7. With the pumps and motor aligned, insert the optional LONG mounting screws through the mounting holes in both pumps, until they make contact with the threaded mounting holes in the motor.
6. Tighten the long screws fully with a small flathead screwdriver.

3.2 Selecting Tubing

Select a tubing material and size that is right for your application (the fluid and flow rate that you are pumping).

Table 9-2 in Chapter 9, shows the average flow rates for different size tubing. Normalized flow rates (mL per revolution) vary significantly, based on motor speed, tubing materials, viscosity, and mechanical tolerances in pump dimensions. Table 9-3 outlines the variances resulting from differences in motor speed, tubing materials, and mechanical tolerances. Table 9-6 outlines the variances due to differences in viscosity.

To determine the chemical compatibility of a particular tubing material, it is recommended that you test the tubing under actual conditions.

Tubing materials that can be used include Vinyl, Viton, Tygon, Silicone, Santoprene, and Norprene. Up to 68 durometer tubing can be used.

NOTE

Poor tubing life results were obtained for $\frac{5}{16}$ " (8.0mm) inner diameter Santoprene tubing. This particular tubing should not be used with the pump motor.

3.3 Tubing Life

Over time and high speeds, flow rates will drop as the tubing wears out. Tubing life for various materials and sizes are shown in Table 9-4 in Chapter 9. Tubing should be periodically inspected for wear. Either move the tubing to a fresh section, or replace tubing entirely (refer to Section 3.4).

3.4 Loading the Tubing

CAUTION

Perform ALL of the steps in Chapter 3 before turning the motor on.

Follow this procedure (refer to Figures 3-8 through 3-12):

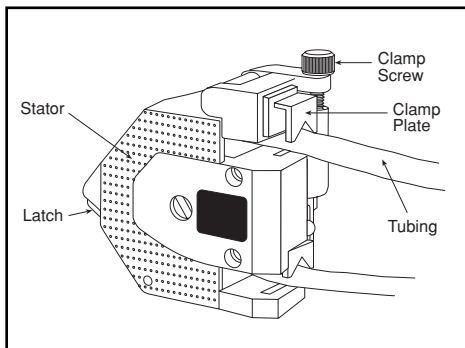

Figure 3-8. Parts of the Pump

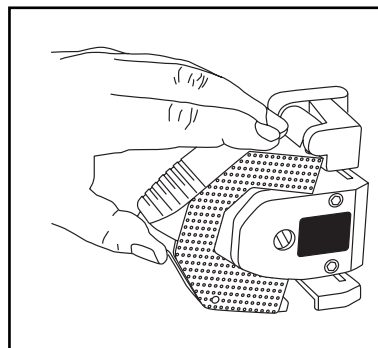

Figure 3-9. Opening the Stator

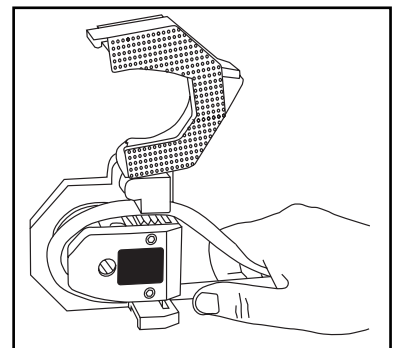

Figure 3-10. Loading the Tubing

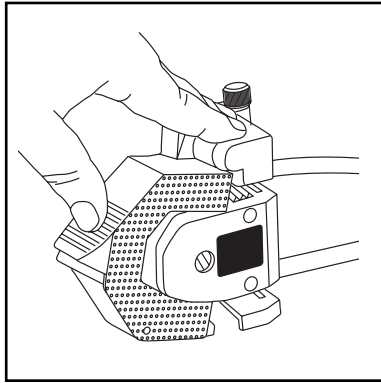

Figure 3-11. Closing the Stator

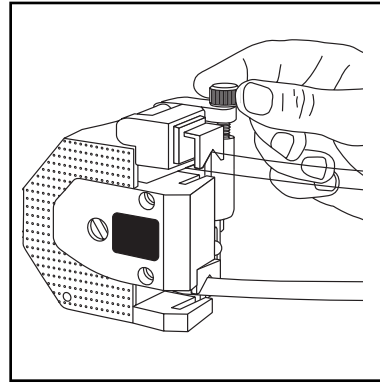

Figure 3-12. Adjusting the Clamp Screw

1. Refer to Figure 3-8 and Figure 3-9. Snap open the Stator by pushing the spring-loaded area of the Latch. Remove any old tubing from the pump, if necessary.
2. Refer to Figure 3-8 and Figure 3-10. Loop the Tubing over the rollers. This is easy to do even for stacked pumps.

NOTE

Tubing can be changed on stacked pumps without detaching either of the pumps from the motor.

3. Refer to Figure 3-11. Push the Stator closed until you hear the Latch engage.
4. Refer to Figure 3-12. Tighten the Clamp Screw until the Clamp Plate contacts the Tubing, securing it in place.
5. Set up the source and drain containers so that the tubing inlet is immersed in the fluid in the source container and the tubing outlet is in the drain container.

NOTE

See Section 5.2 to set the pumping direction.

Notes

Lined area for notes

4.1 Introduction to the Two Display Modes

The pump motor has two modes of operation defined by whether or not the motor is running. Refer to Table 4-1. These two modes are known as the **STOPPED Display Mode** and the **RUNNING Display Mode**.

Table 4-1. STOPPED vs. RUNNING Display Modes

Condition	Status During Stopped Display Mode	Status During Running Display Mode
ON/OFF Switch	ON	ON
Motor	STOPPED	RUNNING
Pump	STOPPED	RUNNING
Display	FLASHING	NOT FLASHING
Green LEDs	NOT FLASHING	FLASHING
Fluid	NOT FLOWING	FLOWING

4.2 Using the ON/OFF Switch

When the ON/OFF switch is pushed upwards the unit's power is on. When the switch is pushed downward, the unit's power is off and the top of the switch labeled "0" is visible.

4.3 The STOPPED Display Mode

To enter the **STOPPED Display Mode**, do the following:

1. Plug in the pump motor to a convenient ac wall outlet. Use ac power within the range of 90 to 130 Vac (for 115 Vac units) or 190 to 260 Vac (for 220 Vac units).

NOTE

A line filter is already installed in the pump motor.

2. Attach the pump(s). Refer to Section 3.1.

- Turn on the unit's power. You are now in the **STOPPED Display Mode** (refer to Figure 4-1). The motor and the pump(s) are stopped. The display flashes, indicating that the pump motor is waiting for you to do something. The non-flashing, green LEDs indicate the tubing inlets (refer to Section 5.2), but fluid is not flowing.

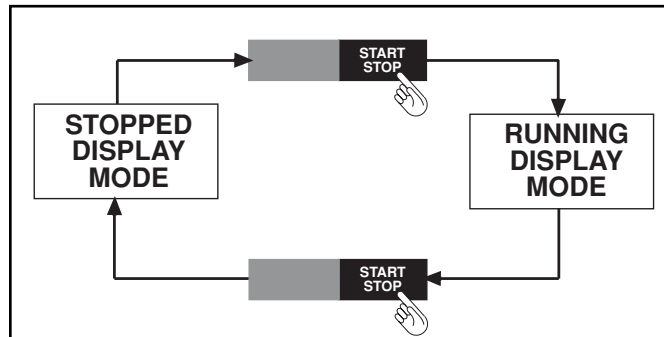

Figure 4-1. STOPPED vs. RUNNING Display Modes

4.4 The RUNNING Display Mode

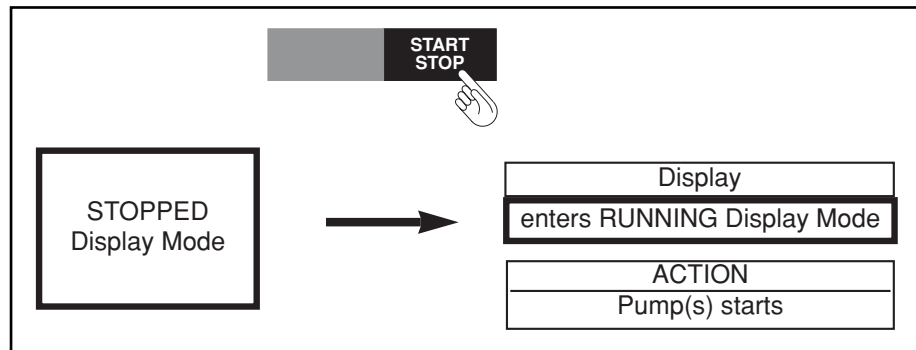
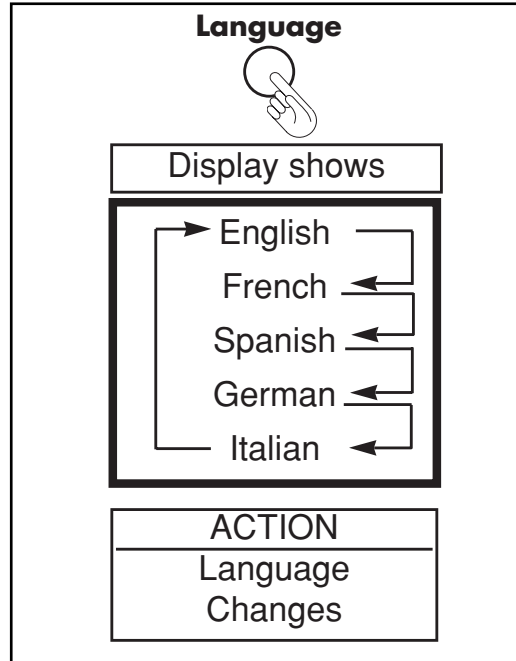

Figure 4-2. RUNNING Display Mode

To enter the **RUNNING Display Mode**, do the following:

- From the **STOPPED Display Mode**, press the *START/STOP* key. You are now in the **RUNNING Display Mode**. Refer to Figure 4-2. The pump motor starts. The attached pump(s) begin pumping fluid. The display is not flashing. The green LEDs flash and point to the tubing inlets.
- Press the *START/STOP* key again. The pump motor stops. Fluid stops dispensing. You return to the **STOPPED Display Mode**.

5.1 Displaying Pump Messages in Five Different Languages



The *LANGUAGE button*, located toward the bottom on the back of the pump motor, changes the language of the pump messages.

1. To display pump messages in another language, press the *LANGUAGE button*. The language of the pump messages changes according to this sequence: English, French, Spanish, German, then Italian. This manual only shows pump messages in English in the display. Table 5-1 shows the English, French, Spanish, German, and Italian messages.
2. If the new language is the language you want, resume pumping. All the pump messages are now in the new language.
3. If the new language is not the one you want, press the *LANGUAGE button* repeatedly, so that the pump motor can cycle through the sequence to reach the proper *LANGUAGE* setting.

Table 5-1. Pump Messages

English	French	Spanish	German	Italian
CAL OVERFLOW CALIBRATED!	DÉPASSEM-ÉTALON! ÉTALONNE!	EXCES. CAL! CALIBRADO!	KAL ÜEBERLAUF! KALIBRIERT!	ECCEDENZA CALIB CALIBRATO
Calibration FAIL	ÉCHEC d'étalon	FALLA Cal.	KalibrierFEHLER	Calib. FALLITA
Dispensing...	Remplissage...	Bombeando...	Pumpe läuft...	Erogaz. in corso
Enter TOTAL VOL.	Entrer QTÉE ÉTAL.	ENT.CANT CAL...	KALMENGE angeben	Indica Q.tà CAL.
Lost PHASE SYNC!	Perte PHASE SYNC!	SINC. FASE PERD!	Keine PHASENSNC!	FASE SINCR persa
OVERCURRENT!	SURCHARGE!	SOBRRECORRIENTE!	ÜEBERSTROM!	SOVRACCORRENTE
Must SET RPM!	RÉGLER RÉGIME!	Ajustar RPM!	U/MIN angeben!	Imposta GIRI/MIN
Must SET TIME!	RÉGLER LA DURÉE!	Programar hora!	ZEIT angeben!	Imposta TEMPO
Set TOTAL VOLUME	RÉGLER LA QTÉE!	Ajustar Cant.!	MENGE angeben!	Imposta Q.tà
Must STOP first!	ARRÊTER d'abord!	Parar primero!	Erst STOP!	Prima FERMARE
not applicable	sans objet	no se aplica	Unzutreffend	non applicabile
not available	sans objet	no disponible	Nicht möglich	non disponibile
not calibrated	non étalonné	sin calibrar	Nicht kalibriert	non calibrato
Prime or START?	Amorcer/DÉMAR.?	Cebat o INICIAR?	Vorpumpen/START?	Adescamo AVVIO?
Priming...	Amorçage	Cebando...	Füllen...	Adescam in corso
Locked Rotor?	Rotor bloqué?	Rotor bloqueado?	Rotor gesperrt?	Rotore bloccato?
Short circuit?	Court-circuit?	Corto circuito?	Kurzschluss?	Corto circuito?
Is pump running?	Pompe en marche?	Bomba en operac?	Läuft Pumpe?	Pompa in uso?
Set RPM or RATE!	Rég. RPM/DÉBIT?	Progr RPM/FLUJO	U/MIN/RATE ang!	GIRI/M o VEL
Select a MODE!	Choisir un MODE!	Selec. MODO!	MODUS wählen!	Selezionare MODO
START or CAL?	DÉMAR./ÉTAL.?	INIC O CAL?	START/KALIBR?	AVVIO O CALIB?
STOP to PRIME...	STOP par AMORC.!	PARAR P/CEBAR...	STOP dann VORPMP.	FERMA per ADESC
CALIBRATED TUBE!	TUBE ETALONNE!	TUBO CALIBRADO!	ROHR KALIBRIERT!	TUBO CALIBRATO!
TUBE ID = 1/32	DI TUBE = 1/32	DI TUBO = 1/32	ROHR ID = 1/32	ID TUBO = 1/32
TUBE ID = 1/16	DI TUBE = 1/16	DI TUBO = 1/16	ROHR ID = 1/16	ID TUBO = 1/16
TUBE ID = 1/8	DI TUBE = 1/8	DI TUBO = 1/8	ROHR ID = 1/8	ID TUBO = 1/8
TUBE ID = 3/16	DI TUBE = 3/16	DI TUBO = 3/16	ROHR ID = 3/16	ID TUBO = 3/16
TUBE ID = 1/4	DI TUBE = 1/4	DI TUBO = 1/4	ROHR ID = 1/4	ID TUBO = 1/4
TUBE ID = 5/16	DI TUBE = 5/16	DI TUBO = 5/16	ROHR ID = 5/16	ID TUBO = 5/16
TUBE ID = 1.0mm	DI TUBE = 1.0mm	DI TUBO = 1,0mm	ROHR ID = 1,0mm	ID TUBO = 1,0mm
TUBE ID = 2.0mm	DI TUBE = 2.0mm	DI TUBO = 2,0mm	ROHR ID = 2,0mm	ID TUBO = 2,0mm
TUBE ID = 3.0mm	DI TUBE = 3.0mm	DI TUBO = 3,0mm	ROHR ID = 3,0mm	ID TUBO = 3,0mm
TUBE ID = 4.0mm	DI TUBE = 4.0mm	DI TUBO = 4,0mm	ROHR ID = 4,0mm	ID TUBO = 4,0mm
TUBE ID = 5.0mm	DI TUBE = 5.0mm	DI TUBO = 5,0mm	ROHR ID = 5,0mm	ID TUBO = 5,0mm
TUBE ID = 6.0mm	DI TUBE = 6.0mm	DI TUBO = 6,0mm	ROHR ID = 6,0mm	ID TUBO = 6,0mm
TUBE ID = 7.0mm	DI TUBE = 7.0mm	DI TUBO = 7,0mm	ROHR ID = 7,0mm	ID TUBO = 7,0mm
TUBE ID = 8.0mm	DI TUBE = 8.0mm	DI TUBO = 8,0mm	ROHR ID = 8,0mm	ID TUBO = 8,0mm
>10,000 Liters!!	>10,000 litres!	>10,000 Litros!	>10,000 Liter!!	>10.000 litri!!
>12:59:59!	>12:59:59!	>12:59:59!	>12:59:59!	>12:59:59!
>12 Hours!!	>12 heures!!	>12 HORAS!!	>12 stunden!!	>12 ore!!
Must SET RATE!	RÉGLER LE DÉBIT!!	ADJISTAR FLUJO!!	RATE angrben!!	INDICARE VELOC.
Press QUANTITY	Presser QTÉE...	Pulsar CANT!	MENGE drücken!	Premi QUANTITA
Press TIME	Presser DURÉE...	Pulsar HORA!	ZEIT drücken!	Premi TEMPO
rpm	régime	rpm	U/min	giri/min
mL	mL	mL	ml	ml
Liters	litres	Litros	Liter	litri
mL/min	mL/min	mL/min	ml/min	ml/min
L/min	L/min	l/min	l/min	l/min
°F	°F	°F	°F	°F
°C	°C	°C	°C	°C

5.2 Defining the Direction of Pumping

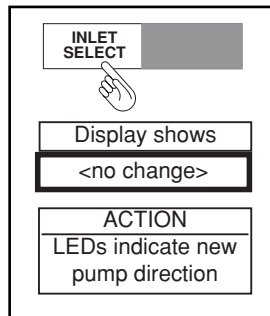

The *INLET SELECT* key, left and right pump icons, and green LEDs define the direction of pumping by specifying the tubing inlets and outlets.

1. Refer to Figure 5-1.
2. To determine the direction of pumping, look at the left and right pump icons and green LEDs. Only one of each pair of LEDs is lit. The lit LED points to the tubing inlet.

NOTE

A top tubing inlet on the left pump corresponds to a bottom tubing inlet on the right pump and vice versa.

Two pumps stacked on one side of the motor will pump fluid in the same direction. Two pumps mounted on opposite sides of the motor will pump fluid in opposing directions.

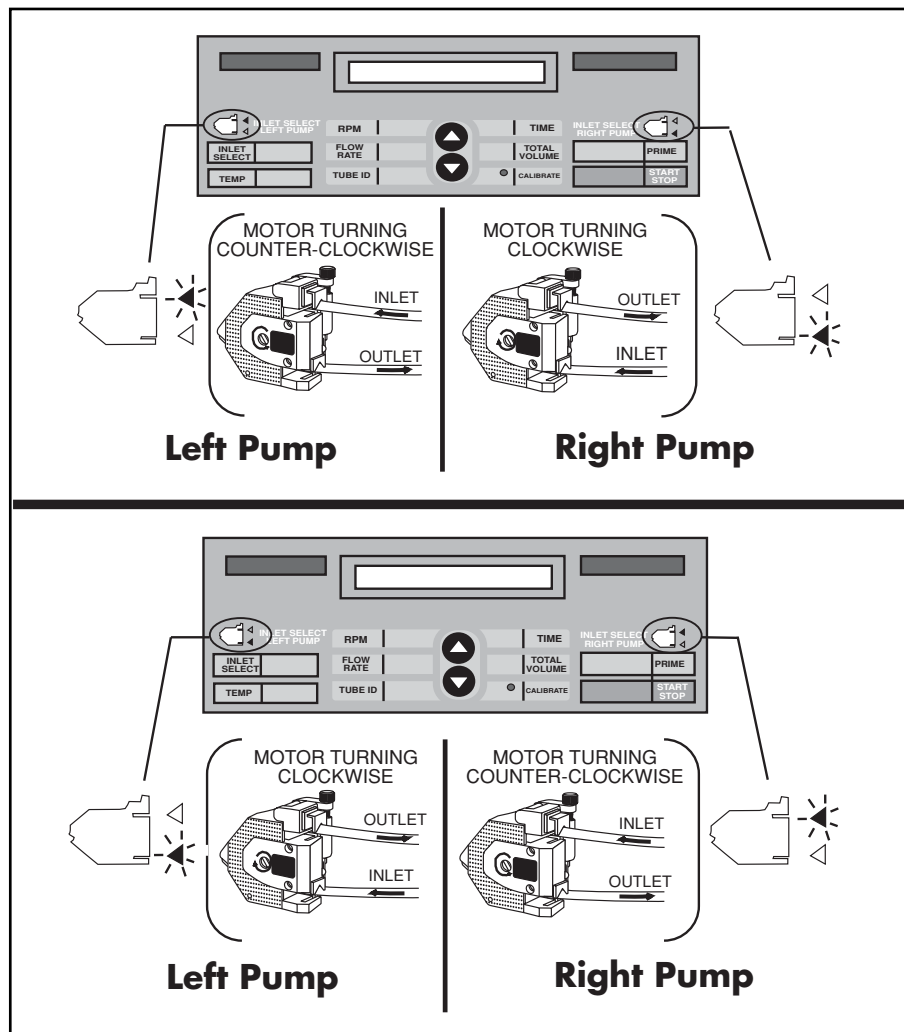

Figure 5-1. Defining the Direction of Pumping

3. To change the direction of pumping, press the *INLET SELECT* key. The lit, green LEDs change positions. Fluid flows in the opposite direction.
4. To change back to the original direction of pumping, simply press the *INLET SELECT* key again.

5.3 Selecting the Tubing Inner Diameter

The *TUBE ID*, and *UP* and *DOWN ARROW* keys allow you to select the inner diameter of the tubing.

NOTE

With the peristaltic pump motor, you can either select a tubing size from those shown in the display (using the *TUBE ID* key), or you can calibrate each piece of tubing you use (using the *CALIBRATE* key, as described in Section 5.5).

1. Press the *TUBE ID* key. The display shows the last TUBE ID setting used, in inches or millimeters. Table 5-2 lists all the pre-programmed tubing inner diameters.
2. Use the *UP and DOWN ARROW* keys to enter a TUBE ID on the display. Once you start the pump motor, after selecting a mode (refer to Chapter 6), the pump will dispense fluid at a flow rate calculated based on the last TUBE ID displayed before the pump starts to run.

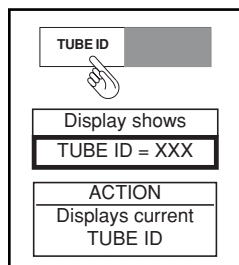

Using the *UP ARROW* key (▲) will cause the TUBE ID value to scroll up through the available choices.

OR

Using the *DOWN ARROW* key (▼) will cause the TUBE ID value to scroll down through the available choices.

NOTE

If the red LED next to the *CALIBRATE* key is lit, the pump motor is running according to the last calibration complete (refer to Section 5.5).

If you press the *TUBE ID* key while the red LED is lit, the display shows "CALIBRATED TUBE!".

Table 5-2. Tube Inner Diameters

Tube Inner Diameters	
English	Metric
1/32"	1.0 mm
1/16"	2.0 mm
1/8"	3.0 mm
3/16"	4.0 mm
1/4"	5.0 mm
5/16"	6.0 mm
	7.0 mm
	8.0 mm

5.4 Priming the Tubing

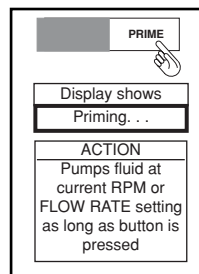

Pressing the *PRIME* key causes the tubing to fill with fluid.

1. To prime the tubing, press and hold down the *PRIME* key. As long as you hold down the *PRIME* key, fluid flows in the tubing, and the display shows "Priming...".
2. To stop priming a tube, simply release the *PRIME* key. The pump motor stops running, and fluid stops flowing.

Extensive testing has shown that the minimum motor speed required to prime the tubing varies significantly with the size of the tubing. These variances are shown in Table 9-3 in Chapter 9. If the tubing will not prime regardless of motor speed, simply press on the pump stator (refer to Figure 3-11) while the stator is shut and the motor is running. Pressing on the stator enhances the priming action of the pump. Release pressure after the tubing is primed.

5.5 Calibrating the Tubing

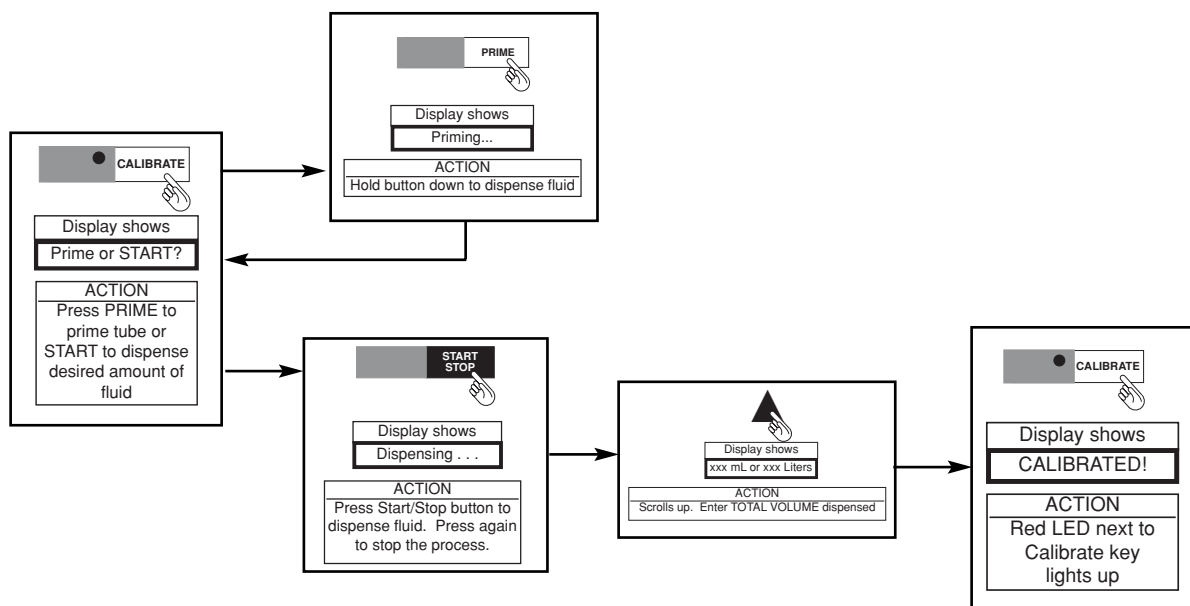

Since tubes of different materials, sizes, ages, and durometers produce different flow rates, the *CALIBRATE* key allows you to calibrate each piece of tubing you use. Calibration accuracy data is shown in Table 9-1 in Chapter 9. Once the tubing is calibrated, you no longer need to be concerned about flow rate variances outlined in Table 9-3.

NOTE

Along with the usual pumping equipment (pump(s), pump motor), you will need calibrated beakers or cylinders to function as source and drain containers.

1. Before you initiate the calibration process, you must set the pump up for pumping in the same direction as you plan to use during normal pump operation (refer to Section 5.2). In addition, make sure the display shows *STOPPED Display Mode* (the motor is not running).
2. Set either the RPM or FLOW RATE setting of the pump motor:
 - 2a. To set the RPM, press the *RPM* key. The display flashes the current RPM setting (xxx rpm). Use the *UP* and *DOWN ARROW* keys to adjust the setting.
 - 2b. To set the FLOW RATE, press the *TUBE ID* key and use the *UP* and *DOWN ARROW* keys to select the inner diameter of the tube you are using. Press the *FLOW RATE* key. Use the *UP* and *DOWN ARROW* keys to adjust the setting.
3. When the display shows the RPM or FLOW RATE setting you desire, you are ready to initiate the calibration process.
4. Press the *CALIBRATE* key. The display should flash and show, "Prime or START ?".
5. To prime the tube, press and hold down the *PRIME* key. As long as you hold down the *PRIME* key, fluid flows in the tube, and the display shows, "Priming...".
6. When fluid has completely filled the tube, simply release the *PRIME* key. The pump motor stops running, and fluid stops flowing.
7. To dispense fluid for calibration, hold the tubing outlet over the drain container and press the *START/STOP* key. Fluid flows, and the display enters the *Running Display Mode*, showing the message, "Dispensing...".
8. When you have allowed fluid to dispense for a minute or two, press the *START/STOP* key to stop the pump. Fluid stops dispensing, and the display returns to the *STOPPED Display Mode*. The display momentarily flashes the message, "Enter TOTAL VOL." and then flashes the total volume dispensed (xxx ml or xxx Liters) alternating with the message "Start or CAL ?".
9. To continue to dispense fluid, press the *START/STOP* key again. Fluid flows, and the display returns to the *Running Display Mode*, showing the message, "Dispensing...".

10. After you have finished dispensing, press the *START/STOP* key to stop the pump motor. Then measure the dispensed fluid's volume using your calibrated beaker.
11. When you have determined the volume of the dispensed fluid, use the *UP* and *DOWN ARROW* keys to enter this volume on the display.
12. Once the display shows the correct volume of fluid dispensed, press the *CALIBRATE* key to complete the calibration. The display flashes and shows, "CALIBRATED!", and the red LED next to the *CALIBRATE* key lights up.
13. Now you can select a mode (RPM, FLOW RATE, TIME or TOTAL VOLUME) (refer to Chapter 6). Once started, the fluid will be pumped according to the calibration.

NOTE

If you replace your tubing, make sure to press the *TUBE ID* key and select a different tube id size using the *UP* or *DOWN ARROW* keys.

NOTE

You can independently calibrate only one pump at a time. If you have two pumps attached to the motor (even if they are stacked), only one of the pumps can be calibrated.

For optimum FLOW RATE or TOTAL VOLUME accuracy, you will need to recalibrate the tubing as a result of:

- Using a different tube size (inner diameter)
 - Using a different tubing material
 - Using a tube of a different age (calibration should be checked every 5-10 hours.)
 - Using a different back pressure in the tube
 - Changing the fluid being pumped
 - Changing the fluid's temperature or density
 - Changing the RPM or FLOW RATE setting
 - Reversing the direction of pumping
 - Changing the clamp screw adjustment of the pump(s)
-

TIPS FOR OPTIMUM CALIBRATION ACCURACY:

Presented below are three useful techniques that will help you obtain optimum calibration accuracy.

- Calibrate the unit at the speed you plan to use for normal pump operation.
- When dispensing fluid during calibration, allow the pump to dispense the largest total volume that your measurement equipment supports.
- When measuring the dispensed fluid during calibration, calculate the volume by measuring the fluid's mass with an accurate gram scale and dividing this mass by the fluid's density.

5.6 Measuring the Temperature of a Fluid

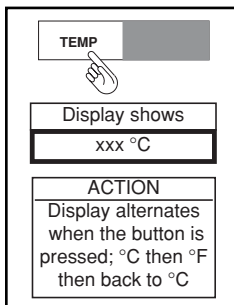

The *TEMP* key displays the temperature of the fluid, as measured via an optional Type K thermocouple probe. The pump motor is equipped with an SMP Type K female thermocouple jack, located near the bottom on the back of the pump motor.

1. To measure the temperature of the fluid, plug one end of an optional Type K thermocouple probe (equipped with an SMP male connector) into the SMP jack and immerse the other end of the probe in the fluid.
2. Press the *TEMP* key. The display shows the fluid's temperature in (°F or °C).
3. If you are reading the temperature in °F and wish to switch to °C (or if you are reading the temperature in °C and wish to switch to °F), press the *TEMP* key again. The display shows the fluid's temperature in the unit of measure to which you switched.

NOTE

If the optional thermocouple probe is not connected to the pump motor, the reading on the display will be 300°F (149°C).

5.7 Preparing for Pumping in a Specific Mode

There are four specific modes in which to pump fluid: RPM, FLOW RATE, TIME, and TOTAL VOLUME. These modes correspond to the criteria the pump motor uses to dispense the fluid. These four modes are described on the next page.

NOTE

When you press the *START/STOP* key and the pump starts running, the active pumping mode is the last mode displayed before you pressed the *START/STOP* key.

Detailed instructions on how to select a pumping mode and adjusting the settings in that mode appear in Chapter 6.

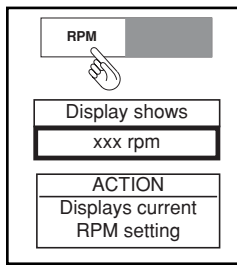

Using the *UP ARROW* key (▲) will cause the RPM setting to scroll up to 600 rpm then roll over to 10 rpm.

OR

Using the *DOWN ARROW* key (▼) will cause the RPM setting to scroll down to 10 rpm then roll over to 600 rpm.

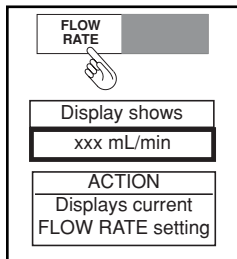

Using the *UP ARROW* key (▲) will cause the FLOW RATE value to scroll up to the maximum FLOW RATE determined by TUBE ID then scrolls over to the minimum FLOW RATE.

OR

Using the *DOWN ARROW* key (▼) will cause the FLOW RATE value to scroll down to the minimum FLOW RATE determined by TUBE ID then scrolls over to the maximum FLOW RATE.

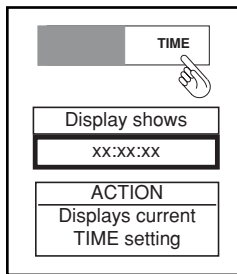

Using the *UP ARROW* key (▲) will cause the flashing TIME setting to scroll up to maximum then roll over to "0". The maximum time is 12 hours, 59 minutes and 59 seconds (12:59:59).

OR

Using the *DOWN ARROW* key (▼) will cause the flashing TIME setting to scroll down to "0" then roll over to the maximum. The maximum time is 12 hours, 59 minutes and 59 seconds (12:59:59).

The flashing group (SECONDS, MINUTES, or HOURS) is the one that will scroll when the *UP* or *DOWN ARROW* key is pressed. Pressing the *TIME* key again will select a different group.

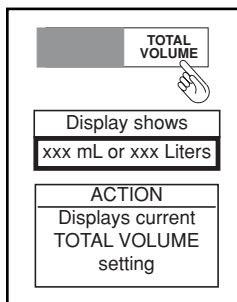

Using the *UP ARROW* key (▲) will cause the display to scroll up to a maximum of 10000 liters then over to 1 mL.

OR

Using the *DOWN ARROW* key (▼) will cause the display to scroll down to 1 mL then roll over to 10000 liters.

Operating the Pump Motor in the RUNNING Display Mode

6.1 The RPM Mode

Figure 6-1 shows the overall block diagram of the RPM Mode in the RUNNING Display Mode.

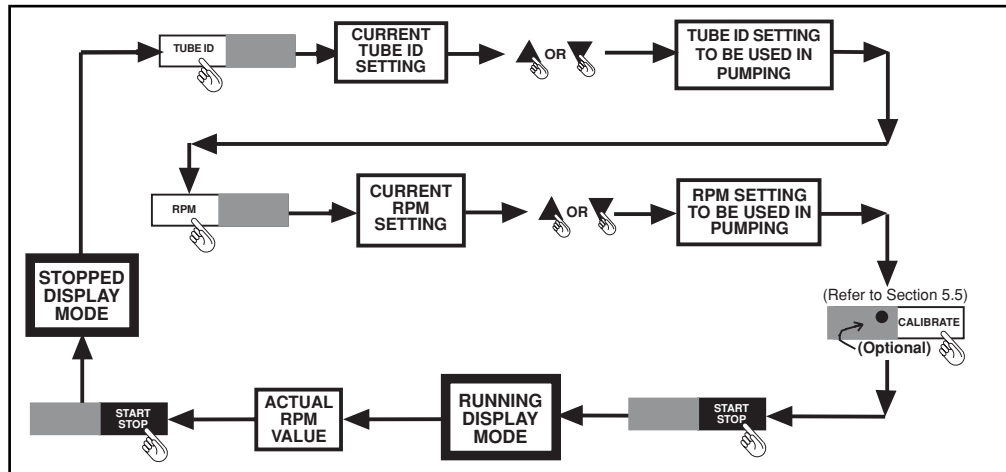

Figure 6-1. Block Diagram: Pumping in the RPM Mode

In the **RPM Mode**, you pump fluid at a certain motor speed, without setting the amount of time you pump or the volume you dispense. The pump motor measures the time of pumping and volume of fluid dispensed but ignores the **TIME** and **TOTAL VOLUME** settings.

6.1.1 Pumping in the RPM Mode

To pump fluid in the **RPM Mode**, do the following:

1. Set up the pump motor for pumping, according to Chapter 3.
2. Toggle the *ON/OFF* switch to turn on the unit's power. The display is in the **STOPPED Display Mode**. Refer to Figure 6-1.
3. Either set the tube ID for the tube you are using (following Section 5.3) or calibrate the tubing (following Section 5.5) before continuing.
4. Press the *RPM* key. The display flashes the current RPM setting (xxx rpm).

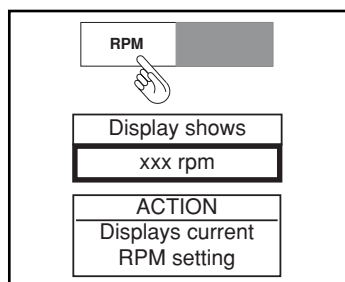

5. Use the *UP* and *DOWN ARROW* keys to enter the RPM setting you desire.

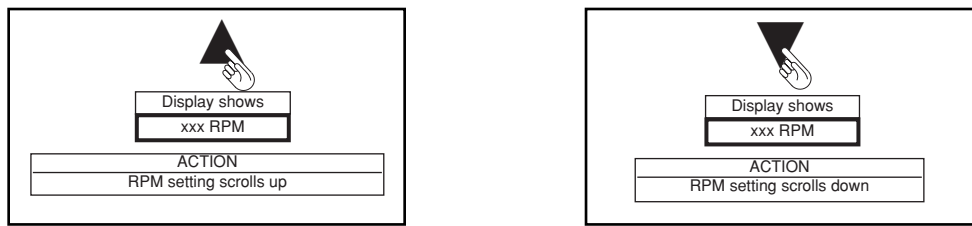

Figure 6-2 shows the range of the RPM numbers you can work with.

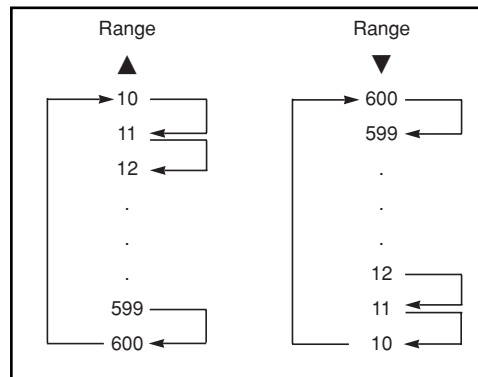
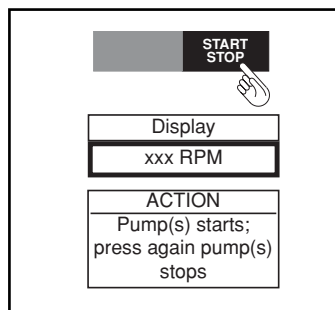

Figure 6-2. RPM Range

5. Once the display shows the RPM setting you desire, press the *START/STOP* key. As the fluid begins to dispense, the non-flashing display shows the actual RPM value of the pump.



NOTE

For details on how to prevent the tubing from moving through the pump, refer to Section 6.5.

6. To stop pumping in the **RPM Mode**, simply press the *START/STOP* key again. The pump stops running, and the display returns to the **STOPPED Display Mode**.

Table 6-1 shows how other keys and buttons can be used while pumping in the RPM mode.

Table 6-1

RPM MODE











KEY	DISPLAY SHOWS	ACTION TAKEN AND PROCEDURE
ON/OFF Switch	xxx rpm	<p><u>Pump motor's power</u></p> <p><i>NOTE: if you turn off the pump motor's power, the pump stops running.</i></p> <p>To continue pumping, turn on the unit's power. The display returns to the STOPPED Display Mode and shows the current RPM setting. The accumulated time of pumping and volume dispensed is reset to zero. Then press the <i>START/STOP</i> key.</p>
	xxx rpm	<p><u>Pump(s) stops: press again pump(s) starts</u></p> <p>To resume pumping at the current setting, press the <i>START/STOP</i> key. The display enters the RUNNING Display Mode, and the fluid begins to dispense.</p>
	Must STOP first!	<p><u>LEDs indicate new pump direction</u></p> <p><u>To select the other inlet and reverse the direction of pumping:</u></p> <ol style="list-style-type: none"> 1. Press the <i>START/STOP</i> key. The display returns to the STOPPED Display Mode. 2. Press the <i>INLET SELECT</i> key to reverse the direction of pumping. 3. Press the <i>START/STOP</i> key again to resume pumping. 4. For detailed instructions on "Defining the Direction of Pumping", refer to Section 5.2.
	STOP to Prime...	<p><u>Pumps fluid at current RPM setting as long as the key is pressed</u></p> <p><u>To prime a tube:</u></p> <ol style="list-style-type: none"> 1. Press the <i>START/STOP</i> key to stop the pump. The display returns to the STOPPED Display Mode. 2. Press and hold down the <i>PRIME</i> key to prime the tube. 3. Press the <i>START/STOP</i> key again to resume pumping. 4. For detailed instructions on "Priming a Tube", refer to Section 5.4.
	xxx °C	<p><u>Display alternates when pressed. °C then °F</u></p> <p><i>NOTE: The TEMP key functions the same whether the pump is stopped or running. Refer to Section 5.6.</i></p>
	xxx rpm	<p><u>Displays current RPM setting</u></p> <ol style="list-style-type: none"> 1. Press the <i>RPM</i> key. The display flashes the RPM setting you selected just before starting the pump. 2. Use the <i>UP</i> and <i>DOWN ARROW</i> keys to enter the RPM setting you desire. As you use the <i>UP</i> and <i>DOWN ARROW</i> keys, the display changes accordingly.
	xx:xx:xx	<p><u>Displays cumulative TIME since start</u></p> <p>Press the <i>TIME</i> key. The display flashes the time that the pump has been running (xx:xx:xx).</p>

Table 6-1 (cont'd)

RPM MODE

KEY	DISPLAY SHOWS	ACTION TAKEN AND PROCEDURE
	xxx mL/min or xxx Liter/min	<p><u>Displays actual FLOW RATE</u></p> <p>Press the <i>FLOW RATE</i> key. The display flashes the fluid flow rate calculated for the RPM setting previously selected (xxx mL/min or xxx L/min).</p>
	xxx mL or xxx Liters	<p><u>Displays current TOTAL VOLUME</u></p> <ol style="list-style-type: none"> 1. Press the <i>TOTAL VOLUME</i> key. The display flashes the calculated volume of fluid dispensed since the pump started running (xxx mL or xxx Liters).
	TUBE ID=xxx	<p><u>Displays current TUBE ID</u></p> <p>Press the <i>TUBE ID</i> key. If the red LED next to the <i>CALIBRATE</i> key is not lit, the display flashes the current TUBE ID setting. If the red LED next to the <i>CALIBRATE</i> key is lit, the display flashes the message "CALIBRATED TUBE!".</p>
	CALIBRATED! or not calibrated	<p><u>Displays calibration state</u></p> <ol style="list-style-type: none"> 1. Press the <i>CALIBRATE</i> key. If the red LED next to the <i>CALIBRATE</i> key is not lit, the display shows "not calibrated".. If the red LED next to the <i>CALIBRATE</i> key is lit, the display shows "CALIBRATED!". <p><u>To calibrate a tube:</u></p> <ol style="list-style-type: none"> 2. Press the <i>START/STOP</i> key to stop the pump. The display returns to the STOPPED Display Mode. For detailed instructions on "Calibrating a Tube", refer to Section 5.5.
	xxx rpm	<p>NOTE: if you press the <i>UP and DOWN ARROW</i> keys, the display shows the current RPM setting. This setting changes accordingly as you use the <i>UP and DOWN ARROW</i> keys but does not wrap around at 10 RPM and 600 RPM while the pump is running. Refer to Figure 6-2.</p>
Language Button		<p>NOTE: if you press the <i>Language button</i>, the display changes to the next language in the sequence: English, French, Spanish, German, and Italian.</p>

6.2 The FLOW RATE Mode

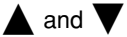
Figure 6-3 shows the overall block diagram of the **FLOW RATE Mode** in the **RUNNING Display Mode**.

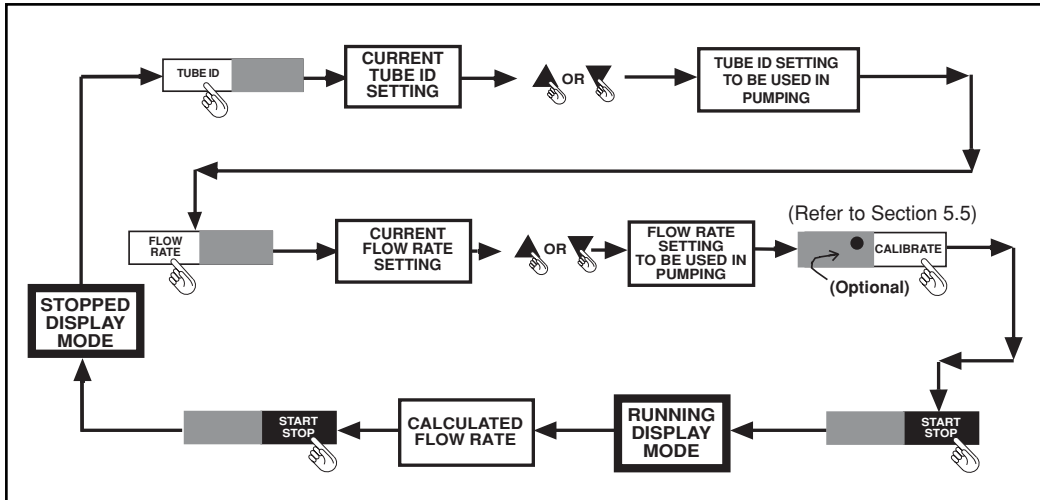

Figure 6-3. Block Diagram: Pumping in the **FLOW RATE Mode**

In the **FLOW RATE Mode**, you pump fluid at a certain flow rate, without setting the amount of time you pump or the amount of fluid you dispense. The pump motor measures the time of pumping and volume of fluid dispensed but ignores the **TIME** and **TOTAL VOLUME** settings.

6.2.1 Pumping in the FLOW RATE Mode

To pump fluid in the **FLOW RATE Mode**, do the following:

1. Set up the pump motor for pumping, according to Chapter 3.
2. Toggle the **ON/OFF switch** to turn on the unit's power. The display is in the **STOPPED Display Mode**. Refer to Figure 6-3.
3. Either set the **TUBE ID** for the tube you are using (following Section 5.3) or calibrate the tube (following Section 5.5), before continuing.
4. Press the **FLOW RATE** key.

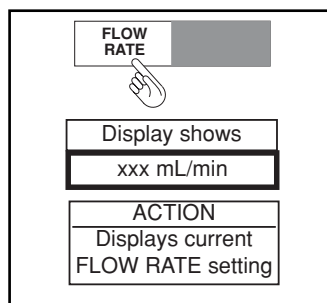

The display flashes the current **FLOW RATE** setting (xxx mL/min or xxx L/min).

5. Use the *UP* and *DOWN ARROW* keys to enter the FLOW RATE setting you desire.

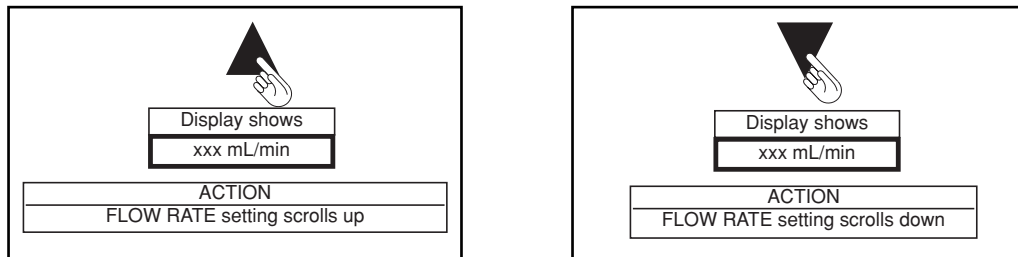

Figure 6-4 shows the ranges allowed for the various tubing sizes.

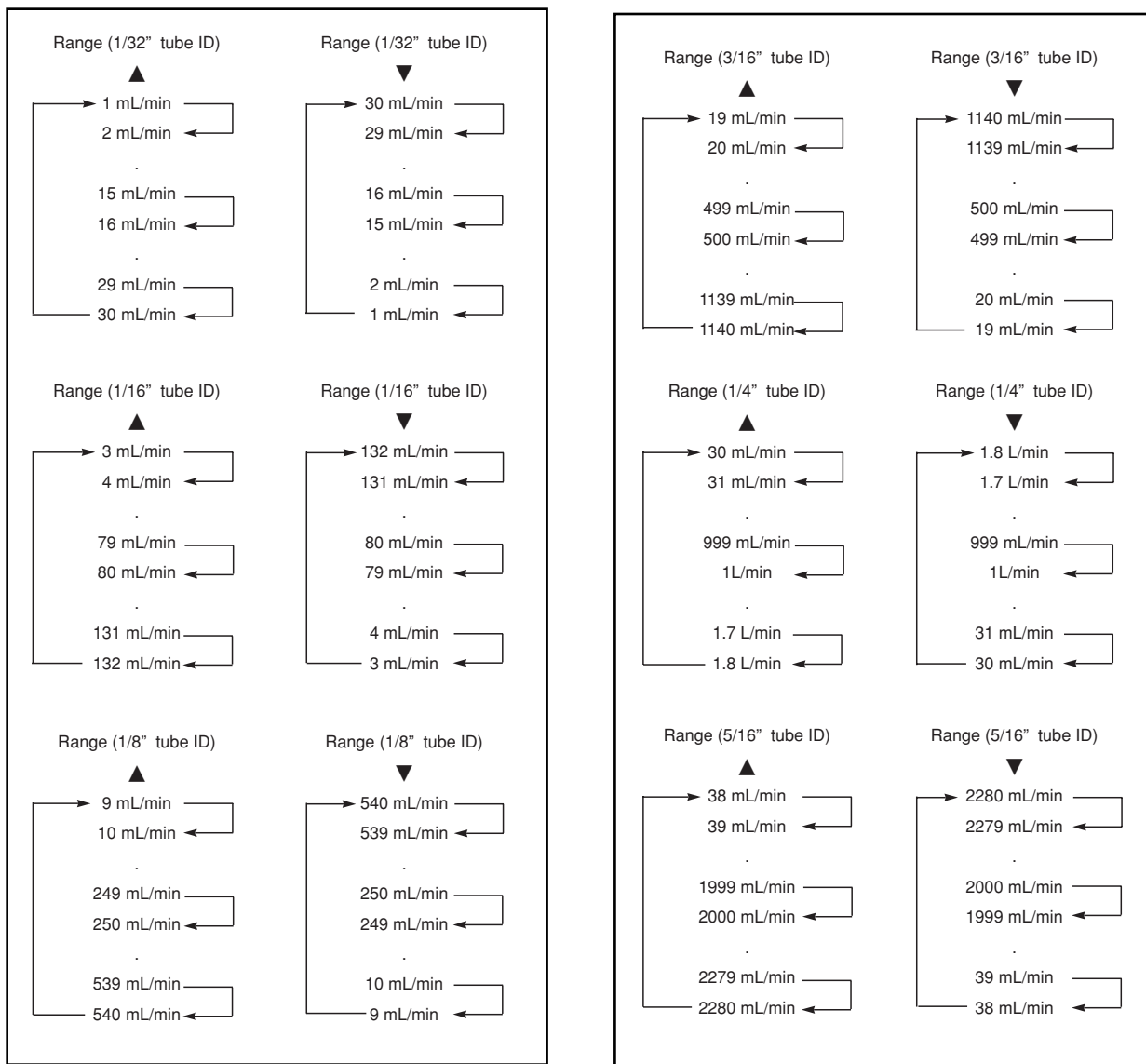

Figure 6-4. FLOW RATE Ranges

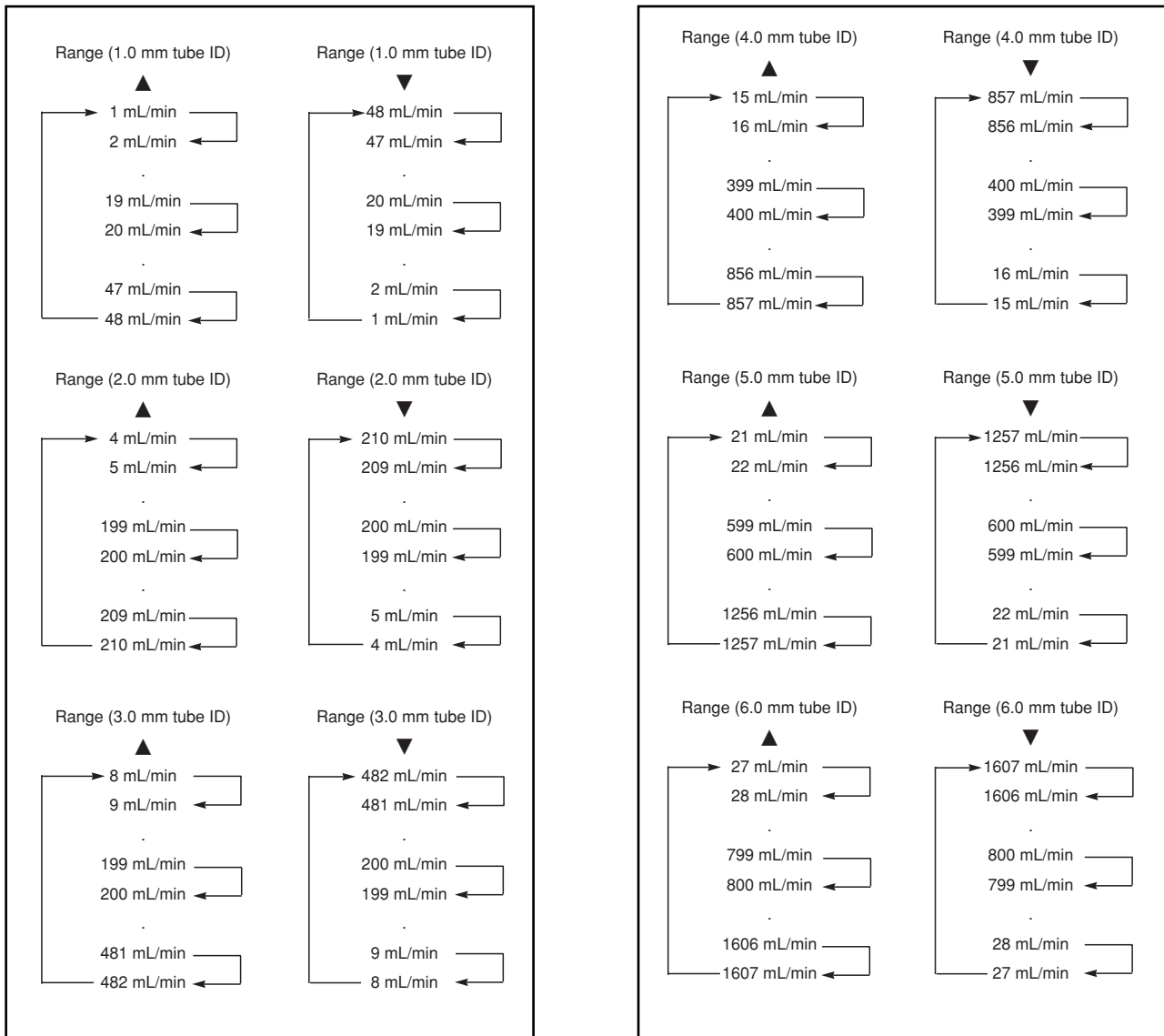

Figure 6-4. FLOW RATE Ranges (cont'd)

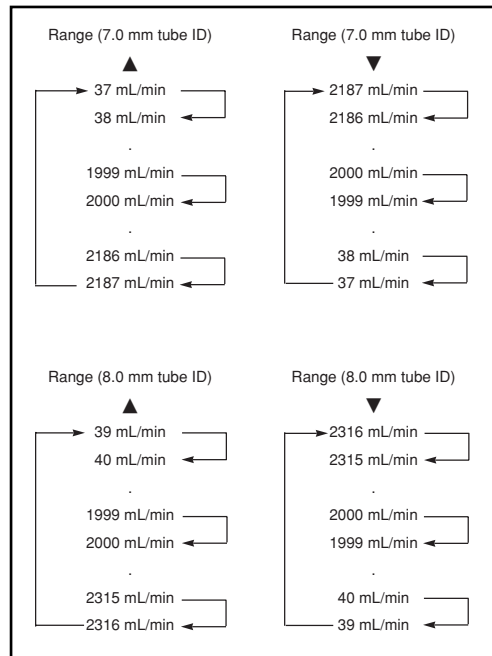
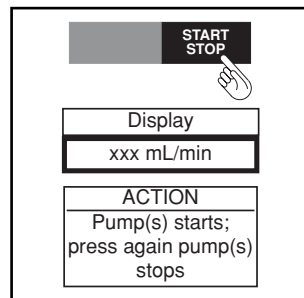

Figure 6-4. FLOW RATE Ranges (cont'd)

- Once the display shows the FLOW RATE setting you desire, press the **START/STOP** key.



As the fluid begins to dispense, the non-flashing display shows the calculated fluid flow rate.

NOTE

Refer to Section 6.5 to learn about how to prevent tubing from moving through the pump.

- To stop pumping in the **FLOW RATE Mode**, simply press the **START/STOP** key again. The pump stops running, and the display returns to the **STOPPED Display Mode**.

Table 6-2 shows how other keys and buttons can be used while pumping in the FLOW RATE mode.

Table 6-2

FLOW RATE MODE











KEY	DISPLAY SHOWS	ACTION TAKEN AND PROCEDURE
ON/OFF Switch	XXX mL/min or XXX L/min	<p><u>Pump motor's power</u></p> <p><i>NOTE: if you turn off the pump motor's power, the pump stops running.</i></p> <p>To continue pumping, turn on the unit's power. The display returns to the STOPPED Display Mode and shows the current FLOW RATE setting. The accumulated time of pumping and volume dispensed is reset to zero. Then press the <i>START/STOP</i> key .</p>
	XXX mL/min or XXX L/min	<p><u>Pump(s) starts: press again pump(s) stops</u></p> <p>To start pumping at this setting, press the <i>START/STOP</i> key. The display enters the RUNNING Display Mode, and the fluid begins to dispense.</p>
	Must STOP first!	<p><u>LEDs indicate new pump direction</u></p> <p><u>To select the other inlet and reverse the direction of pumping:</u></p> <ol style="list-style-type: none"> 1. Press the <i>START/STOP</i> key. The display returns to the STOPPED Display Mode. 2. Press the <i>INLET SELECT</i> key to reverse the direction of pumping. 3. Press the <i>START/STOP</i> key again to resume pumping. 4. For detailed instructions on "Defining the Direction of Pumping", refer to Section 5.2.
	STOP to Prime...	<p><u>Pumps fluid at current flow rate setting as long as the key is pressed</u></p> <p><u>To prime a tube:</u></p> <ol style="list-style-type: none"> 1. Press the <i>START/STOP</i> key to stop the pump. The display returns to the STOPPED Display Mode. 2. Press and hold down the <i>PRIME</i> key to prime the tube. 3. Press the <i>START/STOP</i> key again to resume pumping. 4. For detailed instructions on "Priming a Tube", refer to Section 5.4.
	xxx °C	<p><u>Display alternates when pressed. °C then °F</u></p> <p><i>NOTE: The TEMP key functions the same whether the pump is stopped or running. Refer to Section 5.6.</i></p>
	xxx rpm	<p><u>Displays actual RPM</u></p> <p>Press the <i>RPM</i> key. The display flashes the actual pump motor speed (xxx rpm).</p>

Table 6-2 (cont'd)

FLOW RATE MODE

KEY	DISPLAY SHOWS	ACTION TAKEN AND PROCEDURE
	xx:xx:xx	<p><u>Displays cumulative TIME since start</u></p> <p>Press the <i>TIME</i> key. The display flashes the time that the pump has been running (xx:xx:xx).</p>
	xxx mL/min or xxx L/min	<p><u>Displays current FLOW RATE setting</u></p> <ol style="list-style-type: none"> 1. Press the <i>FLOW RATE</i> key. The display flashes the flow rate setting you selected just before starting the pump. 2. Use the UP and DOWN ARROW keys to enter the FLOW RATE setting you desire. As you use the UP and DOWN ARROW keys, the display changes accordingly. Refer to Figure 6-4.
	xxx mL/min or xxx Liters	<p><u>Displays current TOTAL VOLUME</u></p> <p>Press the <i>TOTAL VOLUME</i> key. The display flashes the calculated volume of fluid dispensed since the pump started running (xxx mL or xxx Liters).</p>
	TUBE ID=xxx	<p><u>Displays current TUBE ID</u></p> <p>Press the <i>TUBE ID</i> key. If the red LED next to the <i>CALIBRATE</i> key is not lit, the display flashes the current TUBE ID setting. If the red LED next to the <i>CALIBRATE</i> key is lit, the display flashes the message "CALIBRATED TUBE!".</p>
	CALIBRATED! or not calibrated	<p><u>Displays calibration state</u></p> <ol style="list-style-type: none"> 1. Press the <i>CALIBRATE</i> key. If the red LED next to the <i>CALIBRATE</i> key is not lit, the display shows "not calibrated". If the red LED next to the <i>CALIBRATE</i> key is lit, the display shows "CALIBRATED!". <p><u>To calibrate a tube:</u></p> <ol style="list-style-type: none"> 2. Press the <i>START/STOP</i> key to stop the pump. The display returns to the STOPPED Display Mode. For detailed instructions on "Calibrating a Tube", refer to Section 5.5.
	xxx mL/min or xxx L/min	<p>NOTE: if you press the <i>UP and DOWN ARROW</i> keys, the display shows the current FLOW RATE setting. This setting changes accordingly as you use the <i>UP and DOWN ARROW</i> keys but does not wrap around at maximum and minimum values while the pump is running.</p>
Language Button		<p>NOTE: if you press the <i>Language button</i>, the display changes to the next language in the sequence: English, French, Spanish, German, and Italian.</p>

6.3 The TIME Mode

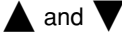
Figure 6-5 shows the overall block diagram of the TIME Mode in the RUNNING Display Mode.

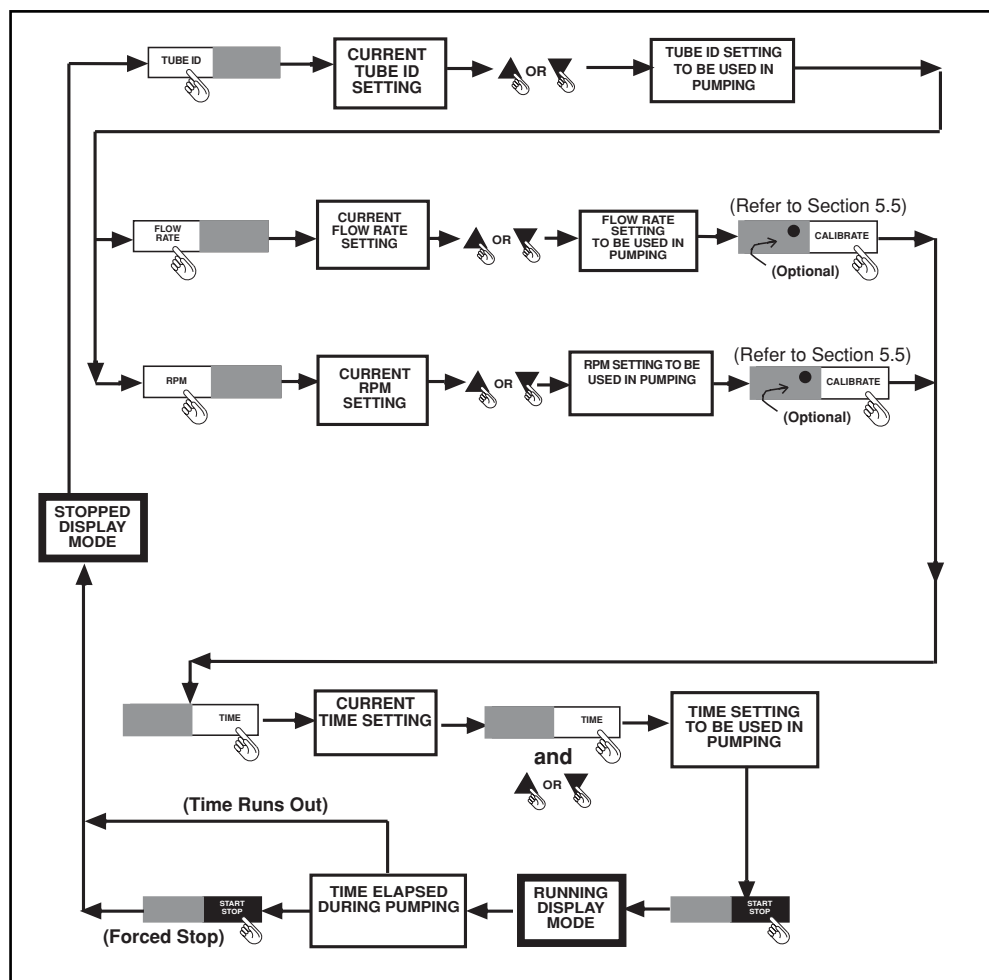

Figure 6-5. Block Diagram: Pumping in the TIME Mode

In the **TIME Mode**, you pump fluid at a certain motor speed or flow rate, for a particular amount of time. The pump motor uses the RPM or FLOW RATE setting. It measures the volume of fluid dispensed, but ignores the TOTAL VOLUME setting.

6.3.1 Pumping in the TIME Mode

To pump fluid in the **TIME Mode**, do the following:

1. Set up the pump motor for pumping according to Chapter 3.
2. Toggle the *ON/OFF switch* to turn on the unit's power. The display is in the **STOPPED Display Mode**. Refer to Figure 6-5.
3. Using the procedure outlined in Sections 6.1.1. and 6.2.1, adjust either the RPM or FLOW RATE setting.

- When the display flashes the RPM or FLOW RATE setting you desire, press the *TIME* key.

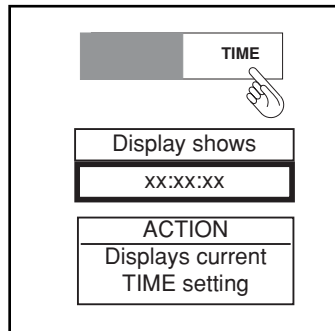

The display shows the current *TIME* setting (xx:xx:xx) with either the *HOURS*, *MINUTES*, or *SECONDS* flashing.

- To change the *HOURS* setting, press the *TIME* key repeatedly, until the *HOURS* flash. Use the *UP* and *DOWN* *ARROW* keys to enter the *HOURS* setting you desire. Figure 6-6 shows the *Time* range.

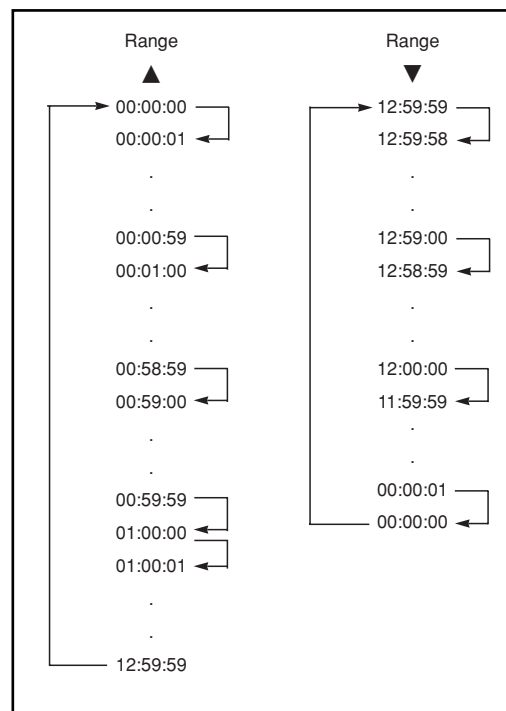
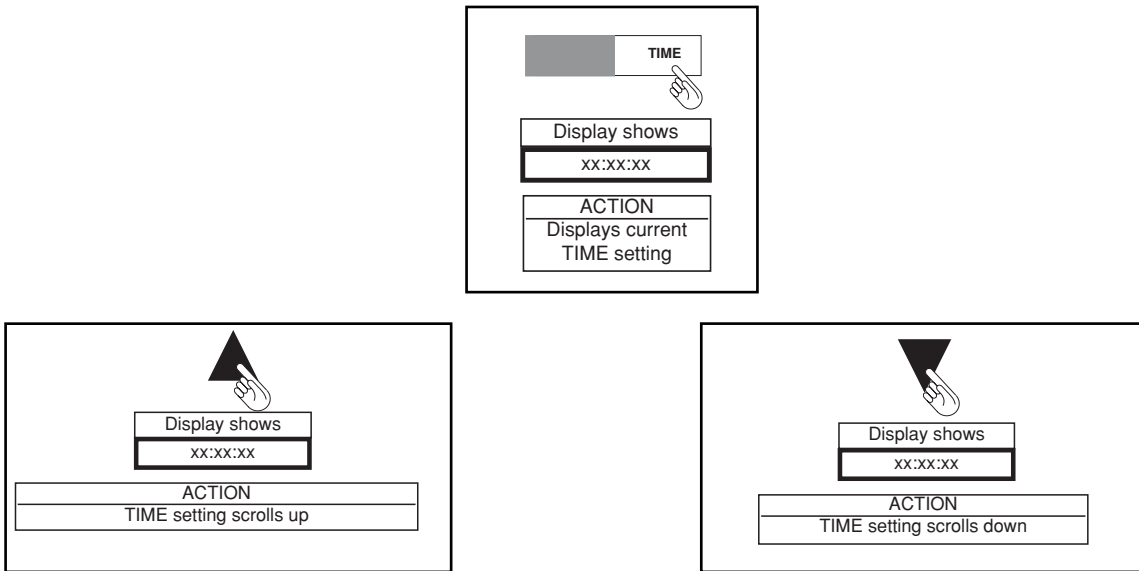
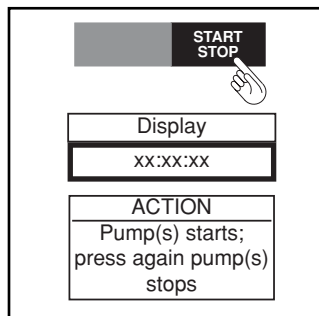

Figure 6-6. *TIME* Range

- To change the *MINUTES* setting, press the *TIME* key repeatedly, until the *MINUTES* flash. Use the *UP* and *DOWN* *ARROW* keys to enter the *MINUTES* setting you desire.



7. To change the **SECONDS** setting, press the *TIME* key repeatedly, until the **SECONDS** flash. Use the *UP* and *DOWN ARROW* keys to enter the **SECONDS** setting you desire.
8. Once the display shows the **TIME** setting you desire, press the *START/STOP* key. As the fluid begins to dispense, the non-flashing display shows the actual time that the pump has been running.



NOTE

In the **TIME Mode**, the pump stops running after it counts up to the **TIME** setting.

To stop pumping before that time, press the *START/STOP* key. The pump stops running, and the display returns to the **STOPPED Display Mode**.

Table 6-3 shows how other keys and buttons can be used while pumping in the **TIME** mode.

Table 6-3

TIME MODE









KEY	DISPLAY SHOWS	ACTION TAKEN AND PROCEDURE
ON/OFF Switch	xx:xx:xx	<p><u>Pump motor's power</u></p> <p><i>NOTE: if you turn off the pump motor's power, the pump stops running.</i></p> <p>To continue pumping, turn on the unit's power. The display returns to the STOPPED Display Mode and shows the time elapsed during pumping. Then press the <i>START/STOP</i> key.</p>
	xx:xx:xx	<p><u>Pump(s) stops: press again pump(s) starts</u></p> <p>To resume pumping for the remainder of the TIME setting, press the <i>START/STOP</i> key. The display enters the RUNNING Display Mode, and the fluid begins to dispense.</p>
	Must STOP first!	<p><u>LEDs indicate new pump direction</u></p> <p><u>To select the other inlet and reverse the direction of pumping:</u></p> <ol style="list-style-type: none"> 1. Press the <i>START/STOP</i> key. The display returns to the STOPPED Display Mode. 2. Press the <i>INLET SELECT</i> key to reverse the direction of pumping. 3. Press the <i>START/STOP</i> key again to resume pumping. 4. For detailed instructions on "Defining the Direction of Pumping", refer to Section 5.2.
	STOP to Prime...	<p><u>Pumps fluid at current rpm or flow rate setting as long as the key is pressed</u></p> <p><u>To prime a tube:</u></p> <ol style="list-style-type: none"> 1. Press the <i>START/STOP</i> key to stop the pump. The display returns to the STOPPED Display Mode. 2. Press and hold down the <i>PRIME</i> key to prime the tube. 3. Press the <i>START/STOP</i> key again to resume pumping. 4. For detailed instructions on "Priming a Tube", refer to Section 5.4.
	xxx °C	<p><u>Display alternates when pressed. °C then °F.</u></p> <p><i>NOTE: The TEMP key functions the same whether the pump is stopped or running. Refer to Section 5.6.</i></p>
	xxx rpm	<p><u>Displays actual RPM</u></p> <p>Press the <i>RPM</i> key. The display flashes the actual pump motor speed (xxx rpm).</p>

Table 6-3 (cont'd)

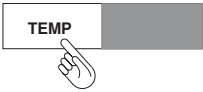
TIME MODE

KEY	DISPLAY SHOWS	ACTION TAKEN AND PROCEDURE
	xx:xx:xx	<p><u>Displays current TIME setting</u></p> <ol style="list-style-type: none"> 1. Press the <i>TIME</i> key. The display flashes the TIME setting you selected just before starting the pump. 2. Use the <i>UP and DOWN ARROW</i> keys to enter the TIME setting you desire. As you use the <i>UP and DOWN ARROW</i> keys, the display changes accordingly. The SECONDS scroll, When you reach 0 or 59 seconds, the minutes setting changes. When you reach 0 or 59 minutes , the HOURS setting changes. Refer to Figure 6-5. <p><i>NOTE: While the pump is running, you can not use the TIME key to toggle from SECONDS to MINUTES TO HOURS.</i></p>
	xxx mL/min or xxx L/min	<p><u>Displays actual FLOW RATE</u></p> <p>Press the <i>FLOW RATE</i> key. The display flashes the calculated fluid flow rate (xxx mL/min or xxx L/min).</p>
	xxx mL or xxx Liters	<p><u>Displays cumulative TOTAL VOLUME since start</u></p> <p>Press the <i>TOTAL VOLUME</i> key. The display flashes the calculated volume of fluid dispensed since the pump started running (xxx mL or xxx Liters).</p>
	TUBE ID=xxx	<p><u>Displays current TUBE ID</u></p> <p>Press the <i>TUBE ID</i> key. If the red LED next to the <i>CALIBRATE</i> key is not lit, the display flashes the current TUBE ID setting. If the red LED next to the <i>CALIBRATE</i> key is lit, the display flashes the message "CALIBRATED TUBE!".</p>
	CALIBRATED! or not calibrated	<p><u>Displays calibration state</u></p> <ol style="list-style-type: none"> 1. Press the <i>CALIBRATE</i> key. If the red LED next to the <i>CALIBRATE</i> key is not lit, the display shows "not calibrated". If the red LED next to the <i>CALIBRATE</i> key is lit, the display shows "CALIBRATED!". <p><u>To calibrate a tube:</u></p> <ol style="list-style-type: none"> 2. Press the <i>START/STOP</i> key to stop the pump. The display returns to the STOPPED Display Mode. For detailed instructions on "Calibrating a Tube", refer to Section 5.5.
	xx:xx:xx	<p><i>NOTE: if you press the UP and DOWN ARROW keys, the display shows the current TIME setting. This setting changes accordingly as you use the UP and DOWN ARROW keys.</i></p>
Language Button		<p><i>NOTE: if you press the Language button, the display changes to the next language in the sequence: English, French, Spanish, German, and Italian. You will not notice this change unless the display shows something other than time. It is easier to change languages when you watch the display change.</i></p>

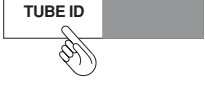
6.4 The TOTAL VOLUME Mode

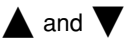
Figure 6-7 shows the overall block diagram of the TOTAL VOLUME Mode in the RUNNING Display Mode.

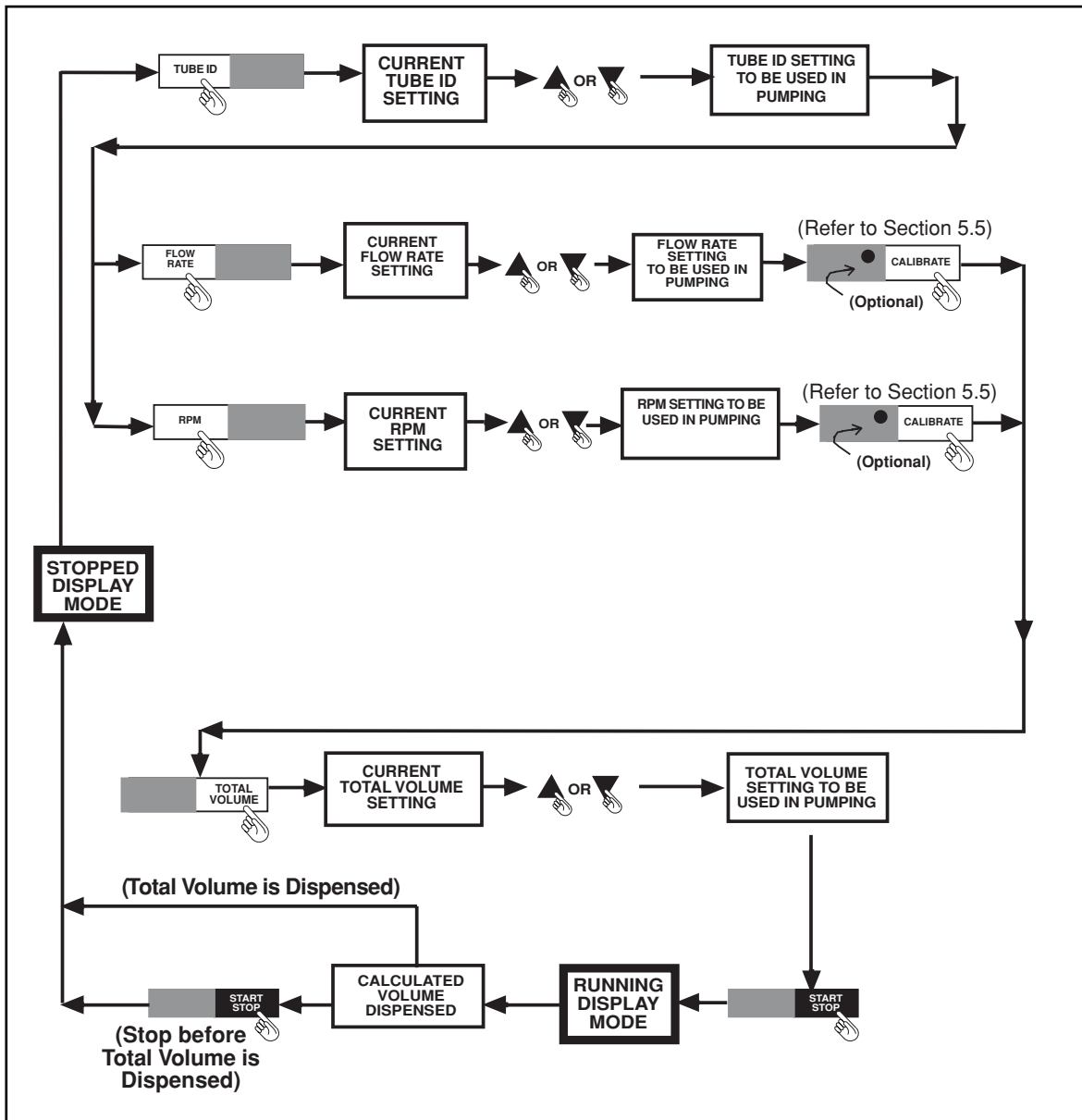

Figure 6-7. Block Diagram: Pumping in the TOTAL VOLUME Mode

In the **TOTAL VOLUME Mode**, you pump a specific quantity of fluid at a certain motor speed or flow rate. The pump motor uses the RPM or FLOW RATE setting. It measures the time of pumping but ignores the TIME setting.

6.4.1 Pumping in the **TOTAL VOLUME Mode**

To pump fluid in the **TOTAL VOLUME Mode**, do the following:

1. Set up the pump motor for pumping, according to Chapter 3.
2. Toggle the *ON/OFF switch* to turn on the unit's power. The display is in the **STOPPED Display Mode**. Refer to Figure 6-7.
3. Using the procedure outlined in Sections 6.1.1. and 6.2.1, adjust either the RPM or FLOW RATE setting.
4. When the display flashes the RPM or FLOW RATE setting you desire, press the *TOTAL VOLUME key*.

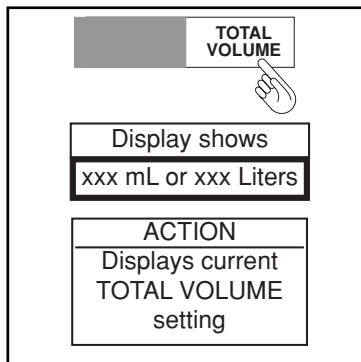

The display flashes the current **TOTAL VOLUME** setting (xxx mL or xxx Liters).

5. Use the *UP and DOWN ARROW keys* to enter the **TOTAL VOLUME** setting you desire. Refer to Figure 6-8 for the **TOTAL VOLUME** range.

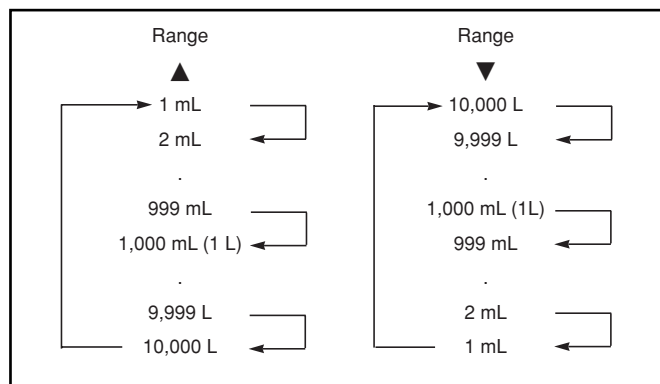
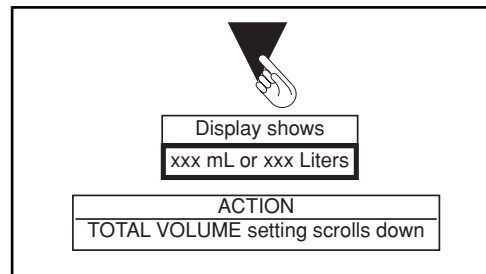
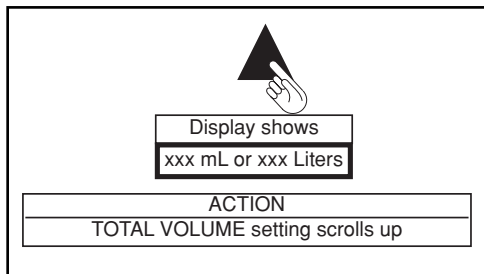

Figure 6-8. **TOTAL VOLUME Range**

6. Once the display shows the **TOTAL VOLUME** setting you desire, press the **START/STOP** key. As the fluid begins to dispense, the non-flashing display shows the calculated volume of dispensed fluid, as it occurs in time.

NOTE

In the **TOTAL VOLUME Mode**, the pump stops running after it dispenses the **TOTAL VOLUME** requested.

To stop pumping before that time, press the **START/STOP** key. The pump stops running, and the display returns to the **STOPPED DISPLAY Mode**.

When the pump stops, the display shows the calculated volume of fluid dispensed.

Do not be alarmed if this number is slightly larger than the **TOTAL VOLUME** you requested. Since the pump motor can not stop instantaneously, this number includes any small amount of fluid that escapes while the pump is in the process of stopping.

Table 6-4 shows how other keys and buttons can be used while pumping in the **TOTAL VOLUME** mode.

Table 6-4

TOTAL VOLUME MODE











KEY	DISPLAY SHOWS	ACTION TAKEN AND PROCEDURE
ON/OFF Switch	xxx mL or xxx Liters	<p><u>Pump motor's power</u></p> <p><i>NOTE: if you turn off the pump motor's power, the pump stops running.</i></p> <p>To continue pumping, turn on the unit's power. The display returns to the STOPPED Display Mode and shows the volume of fluid dispensed during pumping. Then press the <i>START/STOP</i> key.</p>
	xxx mL or xxx Liters	<p><u>Pump(s) stops: press again pump(s) starts</u></p> <p>To resume pumping for the remainder of the TOTAL VOLUME setting, press the <i>START/STOP</i> key. The display enters the RUNNING Display Mode, and the fluid begins to dispense.</p>
	Must STOP first!	<p><u>LEDs indicate new pump direction</u></p> <p><u>To select the other inlet and reverse the direction of pumping:</u></p> <ol style="list-style-type: none"> 1. Press the <i>START/STOP</i> key. The display returns to the STOPPED Display Mode. 2. Press the <i>INLET SELECT</i> key to reverse the direction of pumping. 3. Press the <i>START/STOP</i> key again to resume pumping. 4. For detailed instructions on "Defining the Direction of Pumping", refer to Section 5.2.
	STOP to Prime...	<p><u>Pumps fluid at current rpm or flow rate setting as long as the key is pressed</u></p> <p><u>To prime a tube:</u></p> <ol style="list-style-type: none"> 1. Press the <i>START/STOP</i> key to stop the pump. The display returns to the STOPPED Display Mode. 2. Press and hold down the <i>PRIME</i> key to prime the tube. 3. Press the <i>START/STOP</i> key again to resume pumping. 4. For detailed instructions on "Priming a Tube", refer to Section 5.4.
	xxx °C	<p><u>Display alternates when pressed. °C then °F.</u></p> <p><i>NOTE: The TEMP key functions the same whether the pump is stopped or running. Refer to Section 5.6.</i></p>
	xxx rpm	<p><u>Displays actual RPM</u></p> <p>Press the <i>RPM</i> key. The display flashes the actual pump motor speed (xxx rpm).</p>
	xx:xx:xx	<p><u>Displays cumulative TIME since start</u></p> <p>Press the <i>TIME</i> key. The display flashes the time that the pump has been running (xx:xx:xx:).</p>

Table 6-4 (cont'd)

TOTAL VOLUME MODE

KEY	DISPLAY SHOWS	ACTION TAKEN AND PROCEDURE
	xxx mL/min or xxx L/min	<p style="text-align: center;"><u>Displays actual FLOW RATE</u></p> Press the <i>FLOW RATE</i> key. The display flashes the calculated fluid flow rate (xxx mL/min or xxx L/min).
	xxx mL or xxx Liters	<p style="text-align: center;"><u>Displays current TOTAL VOLUME setting</u></p> <ol style="list-style-type: none"> 1. Press the <i>TOTAL VOLUME</i> key. The display flashes the TOTAL VOLUME setting you selected just before starting the pump. 2. Use the <i>UP and DOWN ARROW</i> keys to enter the TOTAL VOLUME setting you desire. As you use the <i>UP and DOWN ARROW</i> keys, the display changes accordingly.
	TUBE ID=xxx	<p style="text-align: center;"><u>Displays current TUBE ID</u></p> Press the <i>TUBE ID</i> key. If the red LED next to the <i>CALIBRATE</i> key is not lit, the display flashes the current TUBE ID setting. If the red LED next to the <i>CALIBRATE</i> key is lit, the display flashes the message “CALIBRATED TUBE!”.
	CALIBRATED! or not calibrated	<p style="text-align: center;"><u>Displays calibration state</u></p> <ol style="list-style-type: none"> 1. Press the <i>CALIBRATE</i> key. If the red LED next to the <i>CALIBRATE</i> key is not lit, the display shows “not calibrated”. If the red LED next to the <i>CALIBRATE</i> key is lit, the display shows “CALIBRATED!”. <p><u>To calibrate a tube:</u></p> <ol style="list-style-type: none"> 2. Press the <i>START/STOP</i> key to stop the pump. The display returns to the STOPPED Display Mode. For detailed instructions on “Calibrating a Tube”, refer to Section 5.5.
▲ and ▼	xxx mL or xxx Liters	<p><i>NOTE: if you press the UP and DOWN ARROW keys, the display shows the current TOTAL VOLUME setting. This setting changes accordingly as you use the UP and DOWN ARROW keys.</i></p>
Language Button		<p><i>NOTE: if you press the Language button, the display changes to the next language in the sequence: English, French, Spanish, German, and Italian.</i></p>

6.5 Preventing Tubing from Moving During Pump Operation

Once you start the pump, you may need to adjust the Clamp Screw slightly, to prevent the tube from creeping (moving) through the pump. Creeping tends to occur on tubing of larger sizes and tubing made from low friction materials (for example, Santoprene). Use the following procedure to eliminate creeping. Refer to Figure 6-9.

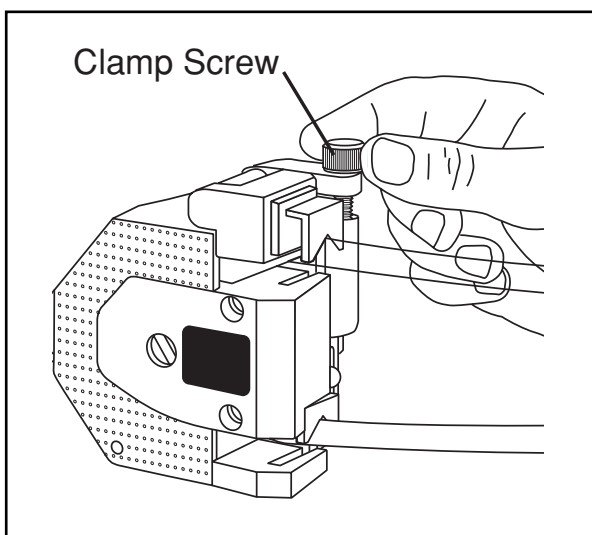

Figure 6-9. Adjusting the Clamp Screw

1. Press the *START/STOP* key to stop the pump (motor).
2. Rotate the Clamp Screw a quarter turn clockwise, in order to increase the pressure of the Clamp Plate on the tubing.
3. Press the *START/STOP* key again (to restart the pump). Observe the tubing. If the tubing has not stopped creeping, go back to Step 1. Otherwise, continue pumping.

6.6 Other Pumping Options

The pump motor is equipped with two features that allow limited remote control and monitoring capability. These features are described in Sections 6.6.1 and 6.6.2. The features are independent. Either one or both may be used at any time.

6.6.1 Auxiliary Out (Remote Monitor)

The Auxiliary Out function allows you to remotely monitor whether the pump motor is running or stopped. The Auxiliary Out terminals are located near the bottom, on the back of the pump motor, next to the *LANGUAGE* button. Use the schematic circuit (Figure 6-10) (Resistor, LED and 9Vdc supply must be user supplied) to monitor the motor.

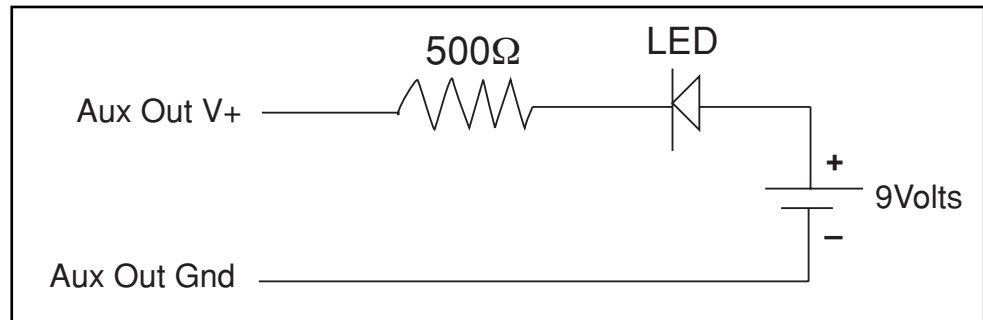

Figure 6-10. Schematic of Auxiliary Out Circuit

1. Connect the circuit shown to the Auxiliary Out terminals with the motor stopped.
2. Press the *START/STOP* key. The motor starts, and the LED in the circuit goes off.
3. Press the *START/STOP* key. The motor stops, and the LED in the circuit lights up.

6.6.2 Auxiliary In (Remote Start/Stop)

The Auxiliary In function allows you to remotely start and stop the pump motor. The Auxiliary In terminals are located near the bottom, on the back of the pump motor, next to the Auxiliary Out terminals.

1. Momentarily short the Auxiliary In V+ terminal to the Auxiliary In Ground terminal. The pump starts. The display enters the **RUNNING Display Mode**.
2. Momentarily short the Auxiliary In V+ terminal to the Auxiliary In Ground terminal. The pump stops. The display enters the **STOPPED Display Mode**.

NOTE

The momentary shorting action may be achieved with proper TTL or CMOS circuitry.

7.1 Display Error Messages

Error Message	Problem	Solution
CAL OVERFLOW!	While calibrating, you have allowed the motor to run at a high RPM setting for a very long time, or you have entered a total volume that would result in an inappropriate calibration factor.	<ol style="list-style-type: none"> 1. Repeatedly press the <i>CALIBRATE</i> key until the message "Prime or START?" appears. 2. Repeat calibration but only allow the pump to run for a minute or two. <i>NOTE: Make sure that you measure the volume of the dispensed fluid accurately.</i>
Calibration FAIL	Your attempt to calibrate was unsuccessful.	<ol style="list-style-type: none"> 1. Repeatedly press the <i>CALIBRATE</i> key until the message "Prime or START?" appears. 2. Repeat calibration but only allow the motor to run for a minute or two. <i>NOTE: Make sure that you measure the volume of the dispensed fluid accurately.</i>
Illegal Op Code	<u>A</u> The line voltage may be bad.	<u>A</u> <ol style="list-style-type: none"> 1. Use a multimeter to measure the line voltage used by the pump motor. 2. Compare the voltage rating on the unit's label (on the back of the pump motor) with the line voltage to make sure that you are using the correct voltage. The pump motor requires line voltages of 90 to 130 Vac (for 115 Vac units) or 190 to 260 Vac (for 220 Vac units).

Error Message	Problem	Solution
Illegal Op Code (continued)	<u>B</u> There may be significant electrical noise affecting the pump motor.	3. If the line voltage is inappropriate for the pump motor, move it to another line voltage source. <u>B</u> Check the pumping environment for devices that could be creating electrical noise. If possible, shut off these devices or move the pump to another location.
	<u>C</u> There may be a problem with the microprocessor.	<u>C</u> Turn the unit's power off and on, adjusting the settings, and attempt to resume pumping.
Is pump running?	You have selected a command that requires the pump motor to be running.	1. Press the <i>START/STOP</i> key to start the motor. 2. Verify that the display is in the RUNNING Display Mode and try to select the command again.
Locked Rotor?	The motor should be running, but no pulse interrupts are occurring, so it is not running. To recover from a locked rotor condition, first turn the power switch off and then back on. Then attempt a solution below.	
	<u>A</u> The motor shaft may be locked.	<u>A</u> 1. The tubing may be causing a jam. Observe how the tubing is loaded in the pump head and, if necessary, reload it. 2. Detach the pump(s) and check for a mechanical jam. Substitute another pump, if necessary. 3. Turn the unit's power off and on, adjust the settings, and attempt to resume pumping.

Error Message	Problem	Solution
Locked Rotor? (continued)	<u>B</u> There may be an internal problem.	<u>B</u> For internal problems, call Customer Service.
Lost PHASE SYNC!	There may be an internal problem.	<ol style="list-style-type: none"> 1. Turn the unit's power off and on, adjust the settings, and attempt to resume pumping. 2. If the problem persists, call Customer Service.
Must SET RPM!	<u>A</u> You have attempted to pump in the RPM Mode with the RPM set to 0 rpm.	<u>A</u> <ol style="list-style-type: none"> 1. Press the <i>RPM</i> key. 2. Use the <i>UP</i> and <i>DOWN</i> <i>ARROW</i> keys to adjust the RPM setting. 3. Press the <i>START/STOP</i> key to start the pump.
	<u>B</u> You have attempted to dispense fluid during calibration with the RPM set to 0 rpm.	<u>B</u> <ol style="list-style-type: none"> 1. Press the <i>RPM</i> key. 2. Use the <i>UP</i> and <i>DOWN</i> <i>ARROW</i> keys to adjust the RPM setting. 3. Press the <i>CALIBRATE</i> key to restart the calibration.
Must SET TIME!	You have attempted to pump in the TIME Mode with the TIME set to 00:00:00.	<ol style="list-style-type: none"> 1. Press the <i>TIME</i> key. 2. Toggle from SECONDS to MINUTES to HOURS with the TIME key. 3. Use the <i>UP</i> and <i>DOWN</i> <i>ARROW</i> keys to adjust the TIME setting. 4. Press the <i>START/STOP</i> key to start the pump.

Error Message	Problem	Solution
Must STOP first!	You have attempted to calibrate or change the direction of pumping while the pump is running.	<ol style="list-style-type: none"> 1. Press the <i>START/STOP</i> key to stop the pump. Verify that the display is in the STOPPED Display Mode. 2. For information on how to change the direction of pumping, refer to Section 5.2.
not applicable	You have attempted to perform a function that you can not perform at this time.	Review the instructions for performing the required function and proceed.
not available	You have attempted to perform a function that you can not perform at this time.	Review the instructions for performing the required function and proceed.
OVERCURRENT!	<p>The motor driver board has sensed an overcurrent.</p> <p>To recover from an overcurrent, first turn the power switch off, and then back on. Then attempt solutions 1 through 8.</p>	<ol style="list-style-type: none"> 1. The tubing may be causing a jam. Observe how the tubing is loaded in the pump(s) and, if necessary, reload it. 2. Detach the pump(s) and check for a mechanical jam. Substitute another pump, if necessary. 3. Check to see if the fuse is blown. Replace if necessary. Refer to Chapter 9 for fuse ratings and chapter 8 for instructions on how to replace it. 4. Make sure you are using tubing of the appropriate wall thickness for the pump(s). Refer to Table 9-1, 9-2, or 9-3. 5. Make sure you are using tubing of the appropriate durometer for your pump(s). Try to operate the motor with tubing of 68 or smaller durometer.

Error Message	Problem	Solution
OVERCURRENT! (continued)		<ol style="list-style-type: none"> 6. Make sure the tubing is not caught on the bottom roller. Reposition the roller slightly and reload the tubing, if necessary. 7. Make sure no part of the tubing is being constricted by a clamp. Loosen clamps if necessary. 8. Turn the unit's power off and on, adjust the settings, and attempt to resume pumping.
Select a MODE!	You have attempted to start the pump, either while the display shows the TUBE ID setting, or after you had entered the volume dispensed in the calibration process.	<ol style="list-style-type: none"> 1. Select a pumping mode (RPM, FLOW RATE, TIME, or TOTAL VOLUME). 2. Press the key that corresponds to that mode. 3. Use the <i>UP and DOWN ARROW</i> keys to adjust the setting. 4. Press the <i>START/STOP</i> key to start the pump.
Set RPM or RATE!	You have selected a command that requires an RPM or FLOW RATE setting to function properly.	<ol style="list-style-type: none"> 1. Press the <i>RPM</i> or <i>FLOW RATE</i> key. 2. Use the <i>UP and DOWN ARROW</i> keys to adjust the setting. 3. Re-enter the original command and proceed.
SET TOTAL VOLUME	You have attempted to start the pump in the TOTAL VOLUME Mode with the TOTAL VOLUME set at 0 mL.	<ol style="list-style-type: none"> 1. Press the <i>TOTAL VOLUME</i> key 2. Use the <i>UP and DOWN ARROW</i> keys to adjust the TOTAL VOLUME setting. 3. Press the <i>START/STOP</i> key to start the pump.

Error Message	Problem	Solution
Short Circuit?	The motor should have stopped, but instead, it is still running.	<ol style="list-style-type: none"> 1. Turn the unit's power off and on, adjust the settings, and attempt to resume pumping. 2. If the problem persists, call Customer Service.
>10,000 Liters!!!	Your pumping has exceeded the maximum volume of 10,000 Liters.	<ol style="list-style-type: none"> 1. If you need to keep track of the amount of fluid dispensed, press the <i>START/STOP</i> key to stop the pump. <i>NOTE: In the future, to keep track of the amount of fluid dispensed, you must stop the pump before it reaches its upper limit of 10,000 liters.</i> 2. If you do not need to keep track of the amount of fluid dispensed, you can ignore this message and let the pump continue to run.
>12:59:59!	Your pumping has exceeded the maximum time of 12:59:59.	<ol style="list-style-type: none"> 1. If you need to keep track of how long the pump has been running, press the <i>START/STOP</i> key to stop the pump. <i>NOTE: In the future, to keep track of how long the pump has been running, you must stop the pump before it reaches its upper limit of 12:59:59.</i> 2. If you do not need to keep track of how long the pump has been running, you can ignore this message and let the pump continue to run.

Error Message	Problem	Solution
<p>Watchdog Failure!</p>	<p><u>A</u> The pump motor's software was unable to track whatever the pump was in the process of doing.</p>	<p><u>A</u> Turn the unit's power off and on, adjust the settings, and attempt to resume pumping.</p>
	<p><u>B</u> The line voltage may be bad.</p>	<p><u>B</u></p> <ol style="list-style-type: none"> 1. Use a multimeter to measure the line voltage used by the pump motor. 2. Compare the voltage rating on the unit's label (on the back of the pump motor) with the line voltage to make sure that you are using the correct line voltage. The pump motor requires line voltages of 90 to 130 Vac (for 115 Vac units) or 190 to 260 Vac (for 220 Vac units). 3. If the line voltage is inappropriate for the pump motor; move it to another line voltage source.
	<p><u>C</u> There may be significant electrical noise affecting the pump motor.</p>	<p><u>C</u> Check the pumping environment for devices that could be creating electrical noise. If possible, shut off these devices or move the pump motor to another location.</p>
	<p><u>D</u> There may be a problem with the microprocessor.</p>	<p><u>D</u> Turn the unit's power off and on, adjusting the settings, and attempt to resume pumping. If the problem persists, call Customer Service.</p>

7.2 Other Pumping Problems

Problem	Solution
No power to unit when <i>ON/OFF switch</i> is in the ON position so that the main circuit board is not getting ac power	<ol style="list-style-type: none"> 1. Make sure the line cord is plugged into an active wall socket. 2. Check to see if the fuse is blown. Replace if necessary. Refer to Chapter 9 for fuse ratings and chapter 8 for instructions on how to replace it. 3. Turn the unit's power off and on, adjust the settings, and attempt to resume pumping.
No flow out of the tube outlet	<p><u>A</u></p> <ol style="list-style-type: none"> 1. Make sure the tubing inlet(s) are immersed in fluid. 2. Observe the green LEDs near the pump icons on the membrane keypad. The lit LEDs point to the inlets. 3. To change the tubing inlets and outlets, make sure the display is in the STOPPED Display Mode and refer to Section 5.2. <p><u>B</u></p> <ol style="list-style-type: none"> 1. Check that the motor is rotating in the correct direction. The pump motor rotates to drive fluid into the inlets and out of the outlets. 2. Observe the green LEDs near the pump icons on the membrane keypad. The lit LEDs point to the inlets. 3. To change the direction in which the motor rotates, make sure the display is in the STOPPED Display Mode and refer to Section 5.2. <p><u>C</u></p> <ol style="list-style-type: none"> 1. Make sure you have properly mounted the pump(s) to the motor. 2. If the pump(s) are not properly mounted, review Section 3.1 on how to attach pump(s) to the motor. 3. Remove and properly attach the pump(s) to the motor.

Problem	Solution
<p>No flow out of the tube outlet (cont'd)</p>	<p><u>D</u> If the previous solutions do not help your situation, there may be a problem with the way the tubing is loaded in the pump(s).</p> <ol style="list-style-type: none"> 1. Observe how the tubing is loaded in the pump(s) and, if necessary, reload it. 2. Make sure the tubing has no holes or cracks. Replace with new tubing, or move a fresh section of the tubing inside of the pump, if necessary. 3. Make sure the tubing is not clogged. Replace with new tubing, if necessary. 4. Make sure no part of the tubing is being constricted by a clamp. Loosen clamps if necessary. 5. Make sure the pump(s) are properly closed.
<p>Fluid flows in the opposite direction of what is intended</p>	<ol style="list-style-type: none"> 1. Check that the motor is rotating in the correct direction. The pump motor rotates to drive fluid into the inlets and out of the outlets. 2. Observe the green LEDs near the pump icons on the membrane keypad. The lit LEDs point to the inlets. 3. To change the direction in which the motor rotates, make sure the display is in the STOPPED Display Mode and refer to Section 5.2.
<p>Unable to fasten two stacked pumps to the motor</p>	<p>Use long mounting screws to attach the pumps.</p>
<p>Motor will not turn</p>	<p><u>A</u></p> <ol style="list-style-type: none"> 1. Verify that the unit's power is on. 2. If the power is not on, toggle the ON/OFF switch to turn on the power. Attempt to resume pumping. <p><u>B</u> The tubing may be causing a jam. Observe how the tubing is loaded in the pump(s) and, if necessary, reload it.</p>

Problem	Solution
<p>Motor will not turn (OVERCURRENT condition)</p> <p>To recover from an overcurrent, first turn the power switch off, and then back on. Then attempt solutions 1 through 8.</p>	<ol style="list-style-type: none"> 1. The tubing may be causing a jam. Observe how the tubing is loaded in the pump(s) and, if necessary, reload it. 2. Detach the pump(s) and check for a mechanical jam. Substitute another pump, if necessary. 3. Check to see if the fuse is blown. Replace if necessary. Refer to Chapter 9 for fuse ratings and chapter 8 for instructions on how to replace it. 4. Make sure you are using tubing of the appropriate wall thickness for the pump(s). Refer to Table 9-1 or 9-2. 5. Make sure you are using tubing of the appropriate durometer for your pump(s). Try to operate the motor with tubing of 68 or smaller durometer. 6. Make sure the tubing is not caught on the bottom roller. Reposition the roller slightly and reload the tubing, if necessary. 7. Make sure no part of the tubing is being constricted by a clamp. Loosen clamps if necessary. 8. Turn the unit's power off and on, adjust the settings, and attempt to resume pumping.
<p>The pump(s) will not stay on the motor</p>	<ol style="list-style-type: none"> 1. Make sure you have properly mounted the pump(s) to the motor. 2. If the pump(s) are not properly mounted, review Section 3.1 on how to attach pump(s) to the motor. 3. Remove and properly attach the pump(s) to the motor.
<p>Pump messages appear in a language other than the one you want</p>	<p>The <i>LANGUAGE button</i> was inadvertently pressed. Make sure that you are pumping in a mode other than the TIME Mode before pressing the <i>LANGUAGE button</i>, so you can watch the language change. To change languages, refer to Section 5.1.</p>
<p>Problem has not been resolved following the suggestions in this chapter</p>	<p>Call Customer Service</p>

8.1 Theory of Operation

The pump motor consists of an electric motor and a pulley assembly controlled by a microprocessor and circuit board. Driven by ac power, the motor produces a torque which drives the pulley assembly. The pulley assembly reduces the motor output speed and drives the pump. All of the pump motor's functions are regulated by the microprocessor and circuit board. You enter information to the motor via a membrane keypad.

8.2 Design Considerations

Customers commonly desire a pump motor that they can calibrate to obtain accurate flow rates with a wide variety of tubing materials, sizes, and durometers. They also want the ability to pump fluid from more than one source container at the same time. In addition, they may need the freedom to pump fluid in opposing directions at the same time. Customers also desire a variety of ways by which to pump their fluid. Above all, they want to carry out all these processes with a user-friendly piece of equipment.

8.3 Design Solution

The peristaltic pump motor satisfies today's diverse customer needs. Its sophisticated software allows customers to calibrate the motor for use with a wide range of tubing materials, sizes, and durometers, to obtain accurate flow rates. It can accept two stacked pumps with fluid flowing in the same direction in both pumps, or one pump on each side with fluid flowing in opposite direction in the pumps. The pump motor is equipped with user friendly software and four modes of pumping: RPM, FLOW RATE, TIME, and TOTAL VOLUME.

8.4 Maintenance

There is no need for any preventive maintenance work. There are no user serviceable parts inside the peristaltic pump motor. All bearings are pre-sealed and rated for long life. Do not open the unit, or the warranty will be voided.

The fuse may be replaced from the outside of the unit. Refer to figure 1.2 for the location. Simply press down on the plastic fuse holder door, and slide it open. The fuse used by the pump motor is closest to the case. The spare fuse is located under the word "Press". Make sure Power is off and the line cord unplugged when changing the fuse.

Maximum Fluid Back Pressure:	20 PSI
Max Suction Lift:	20 feet of H ₂ O (6.1 meters of H ₂ O)
Temperature Range (Fluid):	-50°F to 300°F (-46°C to -149°C)
Flow Rate:	1 to 2280 mL/min
Motor:	Reversible, 75 W (1/10 HP), 90 Vdc (10 to 600 rpm)
Display:	16 character dot matrix LCD, 9 mm (3/8") high characters
Power:	90 to 130 Vac, 1.5 A; 190 to 260 Vac, 0.8 A (Unit may be used with extension cord)
Line cord:	1.8 m (6 ft) with US standard plug on 115 Vac units 1.8 m (6 ft) with European plug on 230 Vac units
Housing:	Painted sheet metal with rubber feet; units are stackable
Dimensions (H x W x D):	152 x 254 x 254 mm (6" x 10" x 10")
Weight:	8.2 kg (18 lb)
Fuse:	2 amp, 110 Vac or 1 amp, 220 Vac

Table 9-1. Calibration Accuracy

Tubing Wall Thickness	Tubing Size Inner Diameter	Calibration Accuracy	Tubing Wall Thickness	Tubing Size Inner Diameter	Calibration Accuracy
1/16"	1/32"	±4%	1.5 mm	1.0 mm	±4%
1/16"	1/16"	±2%	1.5 mm	2.0 mm	±2%
1/16"	1/8"	±2%	1.5 mm	3.0 mm	±2%
1/16"	3/16"	±2%	1.5 mm	4.0 mm	±2%
1/16"	1/4"	±2%	1.5 mm	5.0 mm	±2%
1/16"	5/16"	±4%	1.5 mm	6.0 mm	±2%
			1.5 mm	7.0 mm	±4%
			1.5 mm	8.0 mm	±4%

NOTE

Calibration accuracy studies were done by calibrating the pump motor and comparing actual volume pumped to requested total volume. Various tube materials were used along with 20°C water, 0 PSI back pressure. Accuracies may vary with fluid viscosity, temperature and back pressure.

Flow rate tests were done with 20°C water at 0 PSI back pressure.

Table 9-2. Average Flow Rates

Tubing Wall Thickness	Tubing Size Inner Diameter	mL per Revolution	Minimum Flow Rate at 600 RPM (mL/Minute)	Maximum Flow Rate at 600 RPM (mL/Minute)
1/6"	1/32"	0.05	1	30
1/6"	1/6"	0.22	3	132
1/6"	1/8"	0.9	9	540
1/6"	3/16"	1.9	19	1140
1/6"	1/4"	3.0	30	1800
1/6"	5/16"	3.8	38	2280
1.5 mm	1.0 mm	0.08*	1	48
1.5 mm	2.0 mm	0.35*	4	210
1.5 mm	3.0 mm	0.8*	8	482
1.5 mm	4.0 mm	1.43*	15	857
1.5 mm	5.0 mm	2.1*	21	1257
1.5 mm	6.0 mm	2.7*	27	1607
1.5 mm	7.0 mm	3.6*	37	2187
1.5 mm	8.0 mm	3.9*	39	2316

* Metric mL per revolution numbers are rounded off

To determine the chemical compatibility of a particular tubing material, it is recommended that you test the tubing under actual conditions

Tubing materials that can be used include Vinyl, Viton, Tygon, Silicone, Santoprene, and Norprene. Up to 68 durometer tubing can be used.

Table 9-3. Variances in Normalized Flow Rate (mL per Revolution)

Tubing Size Inner Diameter (in.)	Due to Motor Speed	Between Pumps (due to Mechanical Tolerances)	Due to Different Tubing Materials
1/32	±10%	±25%	±20%
1/6	±10%	±15%	±15%
1/8	±10%	±10%	±5%
3/16	±5%	±10%	±5%
1/4	±5%	±15%	±5%
5/16	±15%	±20%	±10%

Tubing operating life tests are done at 600 RPM, with 20°C water, 0 PSI back pressure until the tubing breaks. Average tubing life hours are shown. However, tubing life varies considerably depending on tubing formulation, tubing back pressure, and fluid pumped. Tubing should be inspected periodically for wear.

Table 9-4. Average Tubing Life

Tubing Wall Thickness (in.)	Tubing Wall Thickness (mm)	Tubing Inner Diameter (in.)	Tubing Inner Diameter (mm)	Material	Average Tubing Life (Hours)
1/6	1.5	1/6	1.5	Viton	10
1/6	1.5	1/8	3.0	Viton	25
1/6	1.5	3/6	4.5	Viton	25
1/6	1.5	1/4	6.0	Viton	25
1/6	1.5	5/6	8.0	Viton	10
1/6	1.5	1/6	1.5	Tygon	60
1/6	1.5	1/8	3.0	Tygon	60
1/6	1.5	3/6	4.5	Tygon	30
1/6	1.5	1/4	6.0	Tygon	30
1/6	1.5	5/6	8.0	Tygon	30
1/6	1.5	1/6	1.5	Silicone	60
1/6	1.5	1/8	3.0	Silicone	60
1/6	1.5	3/6	4.5	Silicone	60
1/6	1.5	1/4	6.0	Silicone	50
1/6	1.5	5/6	8.0	Silicone	40
1/6	1.5	1/6	1.5	Santoprene	100
1/6	1.5	1/8	3.0	Santoprene	100
1/6	1.5	3/6	4.5	Santoprene	100
1/6	1.5	1/4	6.0	Santoprene	75
1/6	1.5	1/6	1.5	Vinyl	60
1/6	1.5	1/8	3.0	Vinyl	60
1/6	1.5	3/6	4.5	Vinyl	60
1/6	1.5	1/4	6.0	Vinyl	40
1/6	1.5	5/6	8.0	Vinyl	30
1/6	1.5	1/6	1.5	Norprene	500
1/6	1.5	1/8	3.0	Norprene	500
1/6	1.5	3/6	4.5	Norprene	500
1/6	1.5	1/4	6.0	Norprene	400
1/6	1.5	5/6	8.0	Norprene	400

NOTE: Poor tubing life results were obtained for 5/6" (8.0mm) inner diameter Santoprene tubing. This particular tubing should not be used with the FPU5-MT Series pump motor.

Table 9-5. Tubing Size vs Min. Motor Speed Required for Priming *

Tubing Size - ID	Minimum Motor Speed (RPM)
1/32"	300
1/16"	250
1/8"	100
3/16"	50
1/4"	50
5/16"	50
1mm	300
2mm	250
3mm	100
4mm	50
5mm	50
6mm	50
7mm	50
8mm	50

(* Tests are done using 20°C water, 0 psi back pressure)

Table 9-6. Average Flow Rates For Viscous Liquids

Liquid	Tubing Wall Thickness	Tubing Size Inner Diameter	mL Per Revolution	Viscosity
Mineral Oil	1/16"	1/32"	0	400 cps
Mineral Oil	1/16"	1/16"	0.005	400 cps
Mineral Oil	1/16"	1/8"	0.04	400 cps
Mineral Oil	1/16"	3/16"	0.15	400 cps
Mineral Oil	1/16"	1/4"	0.20	400 cps
Mineral Oil	1/16"	5/16"	0.25	400 cps
Molasses	1/16"	1/32"	0	8,000 cps
Molasses	1/16"	1/16"	0.002	8,000 cps
Molasses	1/16"	1/8"	0.01	8,000 cps
Molasses	1/16"	3/16"	0.07	8,000 cps
Molasses	1/16"	1/4"	0.08	8,000 cps
Molasses	1/16"	5/16"	0.10	8,000 cps

Flow Rate Tests were done with 20°C liquids at 0 psi back pressure.

The pump motor is equipped with a protective cover, which can be attached to whichever pump mounting site is not being used for pumping. Simply place the cover over the mounting site to avoid catching fingers or clothing in the groove of the motor shaft. Attach it with the two mounting screws provided.

Table 10-1. Spare Parts

Part Number	Description
FPU-0071	Protective Cover
HS-0183S	2 Mounting Screws for Protective Cover
FPU500-SMS	Standard Length Mounting Screws
FPU500-LMS	Long Mounting Screws

Table 10-2. Accessories

Part Number	Description
PROBES WITH 36" TEFLON COATED LEAD WIRES	
KMTSS Series	SMP Type K Thermocouple Stainless Steel Probe $\frac{1}{8}$ Dia *
KMTSS Series	SMP Type K Thermocouple Stainless Steel Probe $\frac{1}{16}$ Dia. *
KMTIN Series	SMP Type K Thermocouple Inconel Probe $\frac{1}{8}$ Dia. *
KMTIN Series	SMP Type K Thermocouple Inconel Probe $\frac{1}{16}$ Dia. *

* When ordering your Type K thermocouple probe, specify grounded or ungrounded. Also, tell the sales person if you need to measure the temperature of corrosive materials. PFA coated probes are recommended for corrosive materials. Consult the Engineering Department for more details.

The sales department will be able to give you the detailed part numbers of the probes you wish to order.

Tubing information is on the next page.

Table 10-2. Accessories (cont'd)

Part Number *	Tubing Type	Size (OD x ID)	Durometer (Shore Hardness)
RECOMMENDED TUBING TYPES AND SIZES			
TYVY Series	Vinyl	$\frac{3}{16} \times \frac{1}{16}$	68
TYVY Series	Vinyl	$\frac{1}{4} \times \frac{1}{8}$	68
TYVY Series	Vinyl	$\frac{5}{32} \times \frac{1}{32}$	68
TYVY Series	Vinyl	$\frac{5}{16} \times \frac{3}{16}$	68
TYVY Series	Vinyl	$\frac{3}{8} \times \frac{1}{4}$	68
TYVY Series	Vinyl	$\frac{7}{16} \times \frac{5}{16}$	68
TYSP Series	Santoprene	$\frac{3}{16} \times \frac{1}{16}$	55 & 64
TYSP Series	Santoprene	$\frac{1}{4} \times \frac{1}{8}$	55 & 64
TYSP Series	Santoprene	$\frac{5}{16} \times \frac{3}{16}$	55 & 64
TYSP Series	Santoprene	$\frac{3}{8} \times \frac{1}{4}$	55 & 64
TYTY Series	Tygon	$\frac{1}{4} \times \frac{1}{8}$	55
TYTY Series	Tygon	$\frac{5}{16} \times \frac{3}{16}$	55
TYTY Series	Tygon	$\frac{3}{8} \times \frac{1}{4}$	55
TYTY Series	Tygon	$\frac{7}{16} \times \frac{5}{16}$	55
TYSC Series	Silicone	$\frac{1}{4} \times \frac{1}{8}$	50 & 60
TYSC Series	Silicone	$\frac{5}{16} \times \frac{3}{16}$	50 & 60
TYSC Series	Silicone	$\frac{3}{8} \times \frac{1}{4}$	50 & 60
TYSC Series	Silicone	$\frac{7}{16} \times \frac{5}{16}$	50 & 60
TYNP Series	Norprene	$\frac{3}{16} \times \frac{1}{16}$	50
TYNP Series	Norprene	$\frac{1}{4} \times \frac{1}{8}$	50
TYNP Series	Norprene	$\frac{5}{16} \times \frac{3}{16}$	50
TYNP Series	Norprene	$\frac{3}{8} \times \frac{1}{4}$	50
TYNP Series	Norprene	$\frac{7}{16} \times \frac{5}{16}$	50
TYVT Series	Viton	$\frac{3}{16} \times \frac{1}{16}$	60
TYVT Series	Viton	$\frac{1}{4} \times \frac{1}{8}$	60
TYVT Series	Viton	$\frac{5}{32} \times \frac{1}{32}$	60
TYVT Series	Viton	$\frac{5}{16} \times \frac{3}{16}$	60
TYVT Series	Viton	$\frac{3}{8} \times \frac{1}{4}$	60

* **Contact the Sales Department for the specific part numbers of the tubing you wish to purchase.**

You can use optional Peristaltic Pumps (Part Number FPU500) with the motor. Figure 10-1 shows a pump. You can attach one pump to each side of the motor or two pumps to either side.

Contact Sales for more information about the pumps.

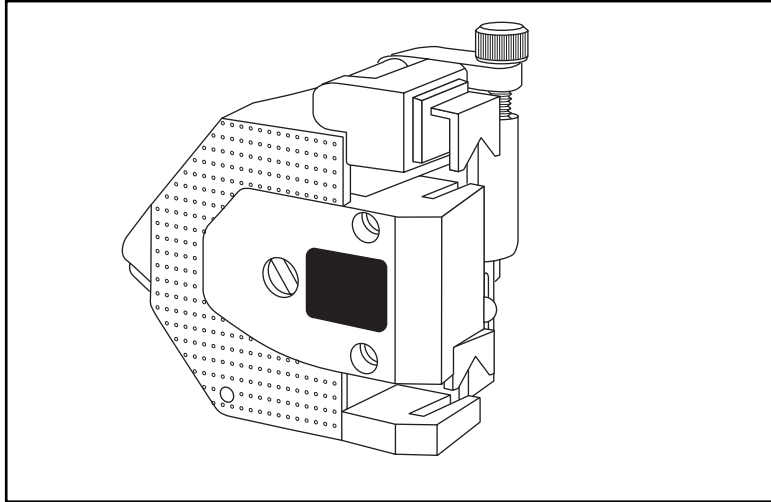

Figure 10-1. Peristaltic Pump

WARRANTY/DISCLAIMER

OMEGA ENGINEERING, INC. warrants this unit to be free of defects in materials and workmanship for a period of **25 months** from date of purchase. OMEGA's WARRANTY adds an additional one (1) month grace period to the normal **two (2) year product warranty** to cover handling and shipping time. This ensures that OMEGA's customers receive maximum coverage on each product.

If the unit malfunctions, it must be returned to the factory for evaluation. OMEGA's Customer Service Department will issue an Authorized Return (AR) number immediately upon phone or written request. Upon examination by OMEGA, if the unit is found to be defective, it will be repaired or replaced at no charge. OMEGA's WARRANTY does not apply to defects resulting from any action of the purchaser, including but not limited to mishandling, improper interfacing, operation outside of design limits, improper repair, or unauthorized modification. This WARRANTY is VOID if the unit shows evidence of having been tampered with or shows evidence of having been damaged as a result of excessive corrosion; or current, heat, moisture or vibration; improper specification; misapplication; misuse or other operating conditions outside of OMEGA's control. Components which wear are not warranted, including but not limited to contact points, fuses, and triacs.

OMEGA is pleased to offer suggestions on the use of its various products. However, OMEGA neither assumes responsibility for any omissions or errors nor assumes liability for any damages that result from the use of its products in accordance with information provided by OMEGA, either verbal or written. OMEGA warrants only that the parts manufactured by it will be as specified and free of defects. OMEGA MAKES NO OTHER WARRANTIES OR REPRESENTATIONS OF ANY KIND WHATSOEVER, EXPRESS OR IMPLIED, EXCEPT THAT OF TITLE, AND ALL IMPLIED WARRANTIES INCLUDING ANY WARRANTY OF MERCHANTABILITY AND FITNESS FOR A PARTICULAR PURPOSE ARE HEREBY DISCLAIMED. LIMITATION OF LIABILITY: The remedies of purchaser set forth herein are exclusive, and the total liability of OMEGA with respect to this order, whether based on contract, warranty, negligence, indemnification, strict liability or otherwise, shall not exceed the purchase price of the component upon which liability is based. In no event shall OMEGA be liable for consequential, incidental or special damages.

CONDITIONS: Equipment sold by OMEGA is not intended to be used, nor shall it be used: (1) as a "Basic Component" under 10 CFR 21 (NRC), used in or with any nuclear installation or activity; or (2) in medical applications or used on humans. Should any Product(s) be used in or with any nuclear installation or activity, medical application, used on humans, or misused in any way, OMEGA assumes no responsibility as set forth in our basic WARRANTY/DISCLAIMER language, and, additionally, purchaser will indemnify OMEGA and hold OMEGA harmless from any liability or damage whatsoever arising out of the use of the Product(s) in such a manner.

RETURN REQUESTS/INQUIRIES

Direct all warranty and repair requests/inquiries to the OMEGA Customer Service Department. BEFORE RETURNING ANY PRODUCT(S) TO OMEGA, PURCHASER MUST OBTAIN AN AUTHORIZED RETURN (AR) NUMBER FROM OMEGA'S CUSTOMER SERVICE DEPARTMENT (IN ORDER TO AVOID PROCESSING DELAYS). The assigned AR number should then be marked on the outside of the return package and on any correspondence.

The purchaser is responsible for shipping charges, freight, insurance and proper packaging to prevent breakage in transit.

FOR **WARRANTY** RETURNS, please have the following information available BEFORE contacting OMEGA:

1. Purchase Order number under which the product was PURCHASED,
2. Model and serial number of the product under warranty, and
3. Repair instructions and/or specific problems relative to the product.

FOR **NON-WARRANTY** REPAIRS, consult OMEGA for current repair charges. Have the following information available BEFORE contacting OMEGA:

1. Purchase Or